

**LE SERIES**  
COMMERCIAL ERV CATALOG

---

# TABLE OF CONTENTS

---

## LE SERIES—Commercial Unitary ERV

MODEL	TYPE	CFM RANGE	PAGE
LE6XINH	Indoor	1,500–6,600 CFM	6–8
LE6XINV	Indoor	1,500–6,600 CFM	9–11
LE6XRT	Rooftop	1,500–6,600 CFM	12–14
LE8XINH	Indoor	2,000–8,800 CFM	15–17
LE8XINV	Indoor	2,000–8,800 CFM	18–20
LE8XRT	Rooftop	2,000–8,800 CFM	21–24
LE10XINH	Indoor	2,500–11,000 CFM	25–27
LE10XINV	Indoor	2,500–11,000 CFM	28–30
LE10XRT	Rooftop	2,500–11,000 CFM	31–34

---

<b>ABOUT RENEWAIRE</b>	2–5
<b>SPECIFICATIONS &amp; DIMENSIONS</b>	6–33
<b>APPLICATIONS</b>	35
<b>OPTIONS &amp; ACCESSORIES</b>	36–49
<b>ORDERING &amp; SUPPORT</b>	50–54

---

# INDOOR AIR QUALITY MATTERS

## DEFICIENT INDOOR AIR QUALITY IS A THREAT

As **buildings get tighter to seal weather out, they seal in contaminants**, causing deficient indoor air quality (IAQ). Typical contaminants include off-gassing from carpeting, furniture and building materials, excess humidity and mold, odors, cooking and cleaning fumes, CO<sub>2</sub>, hair and fibers, to name a few.

**Deficient IAQ is a threat since it can harm occupant health and cognitive function, damage structures and hurt the bottom line.**

It's especially concerning since people spend about 90% of their time indoors, and indoor air can be two to five times—and up to 100 times—more polluted than outdoor air. The EPA ranks indoor air pollution as a top-five health risk.<sup>1</sup>



## ADVERSE EFFECTS OF DEFICIENT IAQ



### HEALTH PROBLEMS

Deficient IAQ can cause allergies, headaches, coughs, asthma, skin irritations and breathing difficulties, as well as cancer, liver disease, kidney damage and nervous-system failure.



### COGNITIVE IMPAIRMENT

Harvard and Berkeley Lab found that CO<sub>2</sub>—a constituent of exhaled breath—negatively impacts thinking and decision-making at levels commonly found indoors.<sup>2</sup>



### DISEASE TRANSMISSION

Ventilation with outdoor air is vital to diluting airborne contaminants and decreasing disease transmission rates.



### REDUCED PRODUCTIVITY

Berkeley Lab found that deficient IAQ can cost \$200 billion in debilitated worker performance and \$58 billion in lost sick time.<sup>3</sup>



Ventilation can enhance IAQ and decrease the transmission of airborne infectious diseases, including COVID-19: [https://bit.ly/COVID19WP\\_22](https://bit.ly/COVID19WP_22)

<sup>1</sup> “Why Indoor Air Quality is Important to Schools,” U.S. Environmental Protection Agency (EPA), <https://bit.ly/2SoyRJc>.

<sup>2</sup> Romm, “Exclusive: Elevated CO<sub>2</sub> Levels Directly Affect Human Cognition, New Harvard Study Shows,” Climate Progress, <https://bit.ly/2Vp6AE2>.

<sup>3</sup> Alevantis, Berman, Mills, Perlman, “The Costs and Financial Benefits of Green Buildings,” U.S. Green Building Council (USGBC), <https://bit.ly/2KnP50c>.

## ABOUT RENEWAIRE

For over 40 years, **RenewAire has been a pioneer in enhancing IAQ** in commercial and residential buildings of every size. This is achieved while maximizing sustainability through our fifth-generation, enthalpic-core, static-plate Energy Recovery Ventilators (ERVs) and Dedicated Outdoor Air Systems (DOAS) that **optimize energy efficiency, lower capital costs and decrease operational expenses** by reducing HVAC loads therefore minimizing equipment needs, resulting in significant energy savings. Our ERVs/DOAS are competitively priced, simple to install, easy to use and maintain, have a quick payback and enjoy the industry’s best warranty with the lowest claims due to long-term reliability. In 2010, RenewAire joined the Soler & Palau (S&P) Ventilation Group, providing direct access to the latest in energy-efficient air-moving technologies. For more information, visit: [renewaire.com](http://renewaire.com).



# RELEVANT EVERYWHERE

## EVERY GEOGRAPHIC REGION

Our ERVs excel in every geographic region.

## EVERY CLIMATE

Our ERVs operate in every climate—from Alaska to Florida, and everywhere in between.

## EVERY PROJECT

From massive skyscrapers to cozy residential homes, our ERVs can be used in every size project and in every code jurisdiction.

## RENEWAIRE TEMPERS THE AIR



Our ERVs moderate the extremes of outdoor supply-air temperature and humidity year-round, providing a sustainable solution for cleaner and healthier air that feels like a perfect spring day.

# APPLIED ANYWHERE

When indoor occupants breathe in unclean air, this harms their health and causes cognitive impairment. Our ERVs can provide cleaner and healthier indoor air for every type of building in the world, thus improving occupants' wellbeing, while also reducing energy costs.

## RESIDENTIAL

The increased airtightness of newer and remodeled homes is causing deficient IAQ, resulting in more health problems for indoor occupants.

## COMMERCIAL

As commercial buildings become more airtight, deficient IAQ is increasing and causing sickness, absenteeism and decreased productivity.

## HEALTHCARE

The high occupant density of hospitals, nursing homes and other healthcare facilities results in deficient IAQ and ensuing health problems for patients and staff alike.

## RESTAURANTS/COFFEE SHOPS

The large volume of indoor occupants in restaurants and coffee shops causes deficient IAQ and subsequent health problems.

## RETAIL

The high level of foot traffic in retail stores leads to deficient IAQ and the potential sickness of shoppers, which can negatively impact sales.

## DAYCARE

Crowded daycare facilities breed deficient IAQ, thus causing health problems for everyone—especially children who are more vulnerable.

## EDUCATION (K-12, COLLEGE/UNIVERSITY)

With students and teachers packed into tight classrooms, instances of deficient IAQ go up, resulting in academic performance and test scores going down.

## GOVERNMENT

Aging and crowded government buildings result in deficient IAQ, which can impair worker performance and productivity.

## EVERY TYPE OF BUILDING

Every type of building can benefit from the enhanced IAQ generated by RenewAire ERVs, including veterinary clinics, nail salons and manufacturing facilities, among others.



# RENEWAIRE ERVs

## ACHIEVE SUSTAINABLE IAQ

OPTIMIZING ENERGY EFFICIENCY IN EVERY GEOGRAPHIC REGION OR CLIMATE

RenewAire residential ERVs are a sustainable ventilation solution. **Our static-plate, cross-flow core separates the outgoing, polluted indoor airstream from the incoming fresh airstream—while simultaneously transferring total energy** (heat and water vapor) between the two. Airstreams do not mix and pollutants are not transferred across partition plates. In the winter, that means that the cold, dry outside air is preheated and humidified by the outgoing warm interior air. And in the summer, the warm, humid outside air is precooled and dehumidified by the outgoing air-conditioned interior air.

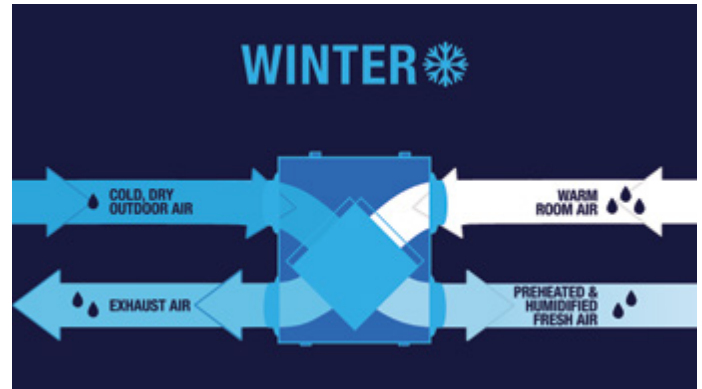
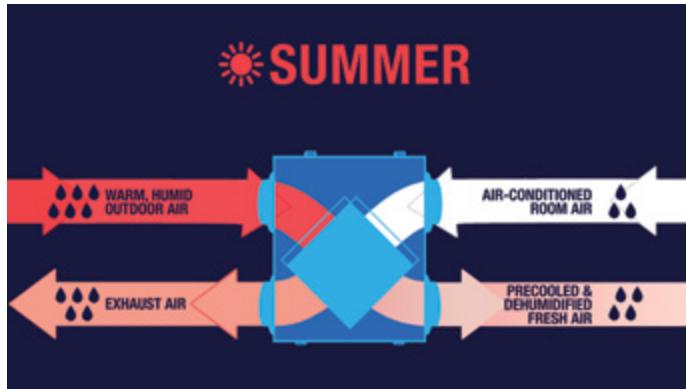

**AIRSTREAMS DO NOT MIX  
& POLLUTANTS ARE NOT TRANSFERRED  
ACROSS PARTITION PLATES**

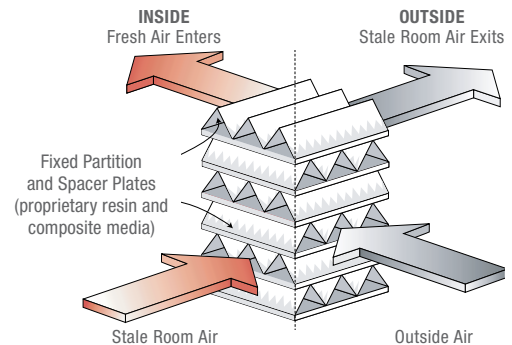

### GREEN BUILDING TRENDS

High-performance, green-building standards seek to reduce energy use and increase ventilation to improve health, wellness, IAQ and indoor environmental quality (IEQ). Sustainable design initiatives like ASHRAE Standard 189.1, LEED, 2030 Challenge, Living Building Challenge and WELL Building Standard have grown in popularity among architects, engineers, contractors and building owners alike.

**RenewAire ventilation technologies create healthier and more comfortable indoor environments**, while optimizing energy efficiency. This is done by reusing otherwise-wasted total energy from the exhaust air to condition incoming outdoor air. The results are exceptional IAQ, IEQ, energy reductions and cost savings.



# WHY RENEWAIRE IS PREFERRED



## BEST VALUE

- ◆ Priced competitively against other energy recovery ventilation technology
- ◆ Due to competitive pricing and decreased costs, payback is short and ROI is maximized
- ◆ Contractors and OEMs can pass these significant savings along to their customers
- ◆ End users can benefit from a significantly reduced operating cost



## RELIABLE OPERATION

- ◆ Built-to-last ERVs have lifespans of 25+ years and operate consistently year-round in every extreme, including frost-free performance in all but the most severe winter climates
- ◆ High-efficiency core operates dry in all conditions, meaning no condensate pans
- ◆ An industry-leading ten-year warranty for the static-plate core, two-year warranty for commercial products



## HIGHEST-QUALITY INDOOR AIR

- ◆ Stale indoor air is replaced with fresh, conditioned and filtered air from the outside, resulting in enhanced IAQ by removing harmful contaminants
- ◆ Airstreams do not mix and pollutants are not transferred across partition plates
- ◆ No biocide used; material does not promote biological growth
- ◆ Moderated temperatures and humidity maintain a comfortable indoor environment
- ◆ Superior product quality results in paramount reliability and longevity



## OPTIMIZED ENERGY EFFICIENCY

- ◆ Efficient heat and humidity transfer recaptures up to 70–80% of the energy exhausted in the airstream
- ◆ Energy that's otherwise wasted by conventional ventilation systems (such as bath fans) is reused, thus dramatically reducing monthly operation costs
- ◆ Energy-efficient operation decreases HVAC loads, which cuts down on energy use and costs
- ◆ The hotter or colder the climate, the more energy is recovered



## HIGHLY CERTIFIED

- ◆ RenewAire products are highly certified. See individual catalog submittal for certification details:
  - ◆ UL
  - ◆ cUL
  - ◆ ETL
  - ◆ AHRI
  - ◆ HVI





ENERGY RECOVERY VENTILATOR



INDOOR UNIT



LE6XINV shown

Energy recovery core is AHRI Certified®



SPECIFICATIONS

**Ventilation Type:** Static plate, heat and humidity transfer

**Typical Airflow Range:** 1,500–6,600 CFM

**AHRI 1060 Certified Core:** Six L125-G5

**Standard Features:**

- TEFC Premium efficiency motors
- Motor starters
- Non-fused disconnect
- 24VAC transformer/relay package
- Cross-core differential pressure ports
- Independent blower control

**Filters:** Total qty. 12, MERV 8: 20" x 25" x 2"

**Unit Weight:**

- Modular (per module) 943–1,367 lbs., varies by option(s)
- Assembled (1-piece) 1,975–2,630 lbs., varies by option(s)

**Max. Shipping Dimensions & Weight (on pallet):**

- Modular (2-modules) 80" L x 90" W x 78" H
- Module 1: 1,508 lbs., Module 2: 1,406 lbs.
- Assembled (1-piece) 160" L x 90" W x 78" H; 2,630 lbs.

**Motor(s):**

- Qty. 2, Belt drive blower/standard motor packages
- with choice of adjustable sheaves (see table below)

**Options:**

- Spring vibration isolators
- Ultra premium efficiency (IE5+) motors with variable frequency drives (VFDs): both airstreams
- Onboard VFDs: both airstreams
- Shaft grounding ring on motors with VFDs
- Fused disconnect
- Integrated programmable controls: enhanced, premium
- Class 1 low leakage motorized isolation dampers: FA, EA or both airstreams
- Factory mounted filter alarms: both airstreams
- Double wall construction
- Exterior paint - white, custom colors

**Accessories:**

- Filters: MERV 13, 2" (shipped loose)
- Automatic balancing damper: 4", 5", 6"
- Digital time clock: wall mount (TC7D-W), in exterior enclosure (TC7D-E)
- Carbon dioxide sensor/control wall mount (CO2-W), duct mount (CO2-D)
- IAQ sensor: wall mount (IAQ-W), duct mount (IAQ-D)
- Motion occupancy sensor/control: ceiling mount (MC-C), wall mount (MC-W)
- Smoke Detector: duct mount (SD-D)
- BACnet fan control: wall mount (BACNETFC-W)
- Indoor electric duct heater: EK series (1–175 kW);
- Indirect gas-fired duct furnace: GH series (50–400 MBH);
- Installed downstream of any fans

AIRFLOW PERFORMANCE

Airflow CFM	External Static Pressure (in.w.g.)																			
	0.00		0.25		0.50		0.75		1.00		1.25		1.50		1.75		2.00			
	BHP	RPM	BHP	RPM	BHP	RPM	BHP	RPM	BHP	RPM	BHP	RPM	BHP	RPM	BHP	RPM	BHP	RPM		
								MOTOR WITH VFD		3 HP LOW SPEED				3 HP MED SPEED						
1500							0.7	720	0.9	820	1.1	900	1.3	960	1.4	1020	1.6	1080	3 HP HIGH SPEED	
2000							0.9	740	1.1	850	1.3	930	1.5	990	1.7	1050	1.9	1100		
2500							1.1	770	1.3	870	1.5	950	1.7	1010	1.9	1060	2.1	1110		
3000					1.1	650	1.4	800	1.6	890	1.8	960	2.0	1020	2.2	1080	2.4	1130		
3500				1.2	620	1.5	740	1.7	840	1.9	910	2.1	980	2.4	1040	2.6	1090	2.8	1140	
3750				1.3	580	1.5	690	1.7	780	1.9	860	2.1	920	2.3	990	2.6	1040	2.8	1100	5 HP MED SPEED
4000	MOTOR WITH VFD	1.6	660	1.7	740	1.9	810	2.1	880	2.3	940	2.6	1000	2.8	1050	3.0	1110	3.3	1160	
4250		1.8	720	2.0	780	2.2	840	2.3	900	2.6	960	2.8	1010	3.0	1060	3.3	1120	3.6	1170	
4500		2.1	770	2.2	820	2.4	870	2.6	920	2.8	970	3.1	1030	3.3	1080	3.6	1130	3.9	1180	
4750	3 HP LOW SPEED	2.4	810	2.5	850	2.7	900	2.9	950	3.1	990	3.3	1040	3.6	1090	3.9	1140	4.2	1190	5 HP HIGH SPEED
5000		2.7	850	2.8	890	3.0	930	3.2	970	3.4	1010	3.7	1060	3.9	1110	4.2	1150	4.5	1210	
5250		3.0	880	3.2	920	3.4	960	3.5	990	3.8	1030	4.0	1080	4.3	1120	4.6	1170	4.9	1220	
5500		3.4	910	3.5	950	3.7	980	3.9	1020	4.1	1060	4.4	1100	4.7	1140	5.0	1190	5.4	1240	
5750	5 HP LOW SPEED	3.8	950	3.9	980	4.1	1010	4.3	1040	4.5	1080	4.8	1120	5.1	1160	5.4	1200	5.8	1260	
6000		4.2	980	4.3	1000	4.5	1030	4.7	1070	5.0	1100	5.2	1140	5.5	1180	5.9	1220	6.3	1270	
6250		4.6	1000	4.8	1030	5.0	1060	5.2	1090	5.4	1120	5.7	1160	6.0	1190	6.3	1240	6.8	1290	
6500		5.1	1030	5.2	1060	5.4	1080	5.6	1110	5.9	1140	6.2	1170	6.5	1210	6.8	1250	7.3	1300	
6600		5.3	1040	5.4	1070	5.6	1090	5.8	1120	6.1	1150	6.4	1180	6.7	1220	7.0	1260	7.5	1310	
		7.5 HP LOW SPEED										7.5 HP MED SPEED								

Note: Airflow performance includes effect of clean, standard filter supplied with unit.





ENERGY RECOVERY VENTILATOR



ELECTRICAL DATA

Electrical Specifications				Motor Starters (Standard)			Optional IE3 Efficiency Motor with VFDs			Optional IE5+ Efficiency Motor with VFDs		
HP	Volts	HZ	Phase	FLA per Motor	Min. Cir. Amps	Max. Overcurrent Protection Device	FLA per Motor	Min. Cir. Amps	Max. Overcurrent Protection Device	FLA per Motor	Min. Cir. Amps	Max. Overcurrent Protection Device
3.0	208-230	60	Single	14.6-14.0	32.9	45.0	9.0-8.4	35.1	50.0	7.3-7.3	28.4	40.0
3.0	208-230	60	Three	9.0-8.4	20.3	25.0	9.0-8.4	20.3	25.0	7.3-7.3	16.4	20.0
	460	60	Three	4.2	9.5	15.0	4.2	9.5	15.0	3.7	8.3	15.0
	575	60	Three	3.3	7.4	15.0	3.3	7.4	15.0			
5.0	208-230	60	Three	13.9-13.4	31.3	45.0	13.9-13.4	31.3	45.0	10.5-10.5	23.6	30.0
	460	60	Three	6.7	15.1	20.0	6.7	15.1	20.0	5.3	11.9	15.0
	575	60	Three	5.3	11.9	15.0	5.3	11.9	15.0			
7.5	208-230	60	Three	20.0-19.0	45.0	60.0	20.0-19.0	45.0	60.0	17.4-17.4	39.2	50.0
	460	60	Three	9.5	21.4	30.0	9.5	21.4	30.0	8.7	19.6	25.0
	575	60	Three	7.6	17.1	20.0	7.6	17.1	20.0			



**LEGXINH ENERGY RECOVERY VENTILATOR**

**ABBREVIATIONS**  
 EA: Exhaust Air to outside  
 OA: Outside Air intake  
 RA: Room Air to be exhausted  
 FA: Fresh Air to inside

**INSTALLATION ORIENTATION**  
 Unit must be installed in orientation shown.

**NOTE**  
 1. UNLESS OTHERWISE SPECIFIED, DIMENSIONS ARE ROUNDED TO THE NEAREST EIGHTH OF AN INCH.  
 2. SPECIFICATIONS MAY BE SUBJECT TO CHANGE WITHOUT NOTICE.  
 3. MIN. DUCT CLEARANCE FROM DAMPER BLADES WHEN FULLY OPENED TO BE 2". SMACNA RULES APPLY.

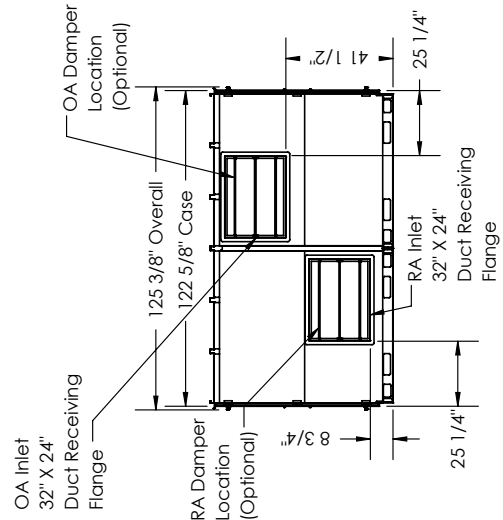
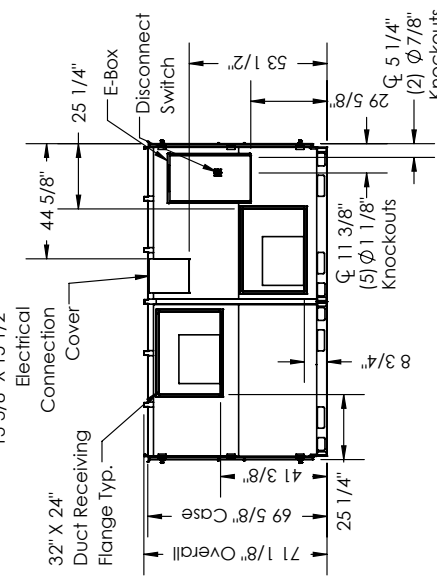
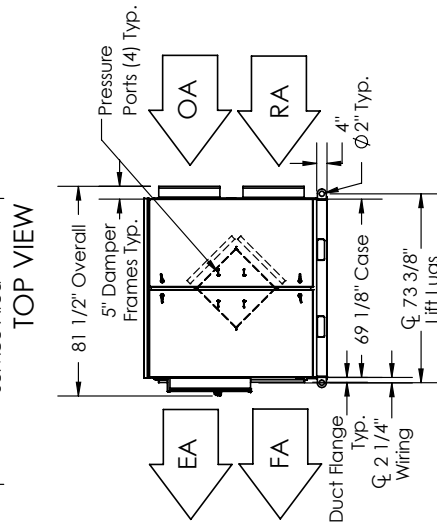
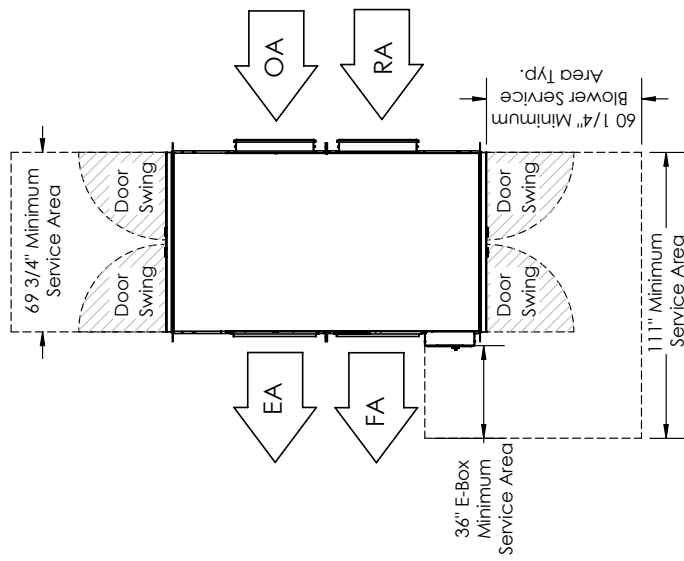

RIGHT VIEW

FRONT VIEW

LEFT VIEW

**UNIT MOUNTING & APPLICATION**

Must be mounted as shown. RA/EA airstream can be switched with OA/FA airstream unless certain options are selected.



**AIRFLOW ORIENTATION**

Available as shown.





ENERGY RECOVERY VENTILATOR



INDOOR UNIT



SPECIFICATIONS

**Ventilation Type:** Static plate, heat and humidity transfer

**Typical Airflow Range:** 1,500–6,600 CFM

**AHRI 1060 Certified Core:** Six L125-G5

**Standard Features:**

- TEFC Premium efficiency motors
- Motor starters
- Non-fused disconnect
- 24VAC transformer/relay package
- Cross-core differential pressure ports
- Independent blower control

**Filters:** Total qty. 12, MERV 8: 20" x 25" x 2"

**Unit Weight:**

- Modular (per module) 715–1,622 lbs., varies by option(s)
- Assembled (1-piece) 1,984–2,640 lbs. varies by option(s)

**Max. Shipping Dimensions & Weight (on pallet):**

- Modular (2-modules) 80" L x 90" W x 78" H
- Module 1: 1,508 lbs., Module 2: 1,406 lbs.
- Assembled (1-piece) 160" L x 90" W x 78" H; 2,922 lbs.

**Motor(s):**

- Qty. 2, Belt drive blower/standard motor packages
- with choice of adjustable sheaves (see table below)

**Options:**

- Spring vibration isolators
- Ultra premium efficiency (IE5+) motors with variable frequency drives (VFDs): both airstreams
- Onboard VFDs: both airstreams
- Shaft grounding ring on motors with VFDs
- Fused disconnect
- Integrated programmable controls: enhanced, premium
- Class 1 low leakage motorized isolation dampers: FA, EA or both airstreams
- Factory mounted filter alarms: both airstreams
- Double wall construction
- Exterior paint - white, custom colors

**Accessories:**

- Filters: MERV 13, 2" (shipped loose)
- Automatic balancing damper: 4", 5", 6"
- Digital time clock: wall mount (TC7D-W), in exterior enclosure (TC7D-E)
- Carbon dioxide sensor/control wall mount (CO2-W), duct mount (CO2-D)
- IAQ sensor: wall mount (IAQ-W), duct mount (IAQ-D)
- Motion occupancy sensor/control: ceiling mount (MC-C), wall mount (MC-W)
- Smoke Detector: duct mount (SD-D)
- BACnet fan control: wall mount (BACNETFC-W)
- Indoor electric duct heater: EK series (1–175 kW);
- Indirect gas-fired duct furnace: GH series (50–400 MBH);
- Installed downstream of any fans

Energy recovery core is AHRI Certified®



AIRFLOW PERFORMANCE

Airflow CFM	External Static Pressure (in.w.g.)																					
	0.00		0.25		0.50		0.75		1.00		1.25		1.50		1.75		2.00					
	BHP	RPM	BHP	RPM	BHP	RPM	BHP	RPM	BHP	RPM	BHP	RPM	BHP	RPM	BHP	RPM	BHP	RPM				
							MOTOR WITH VFD		3 HP LOW SPEED				3 HP MED SPEED									
1500							0.7	720	0.9	820	1.1	900	1.3	960	1.4	1020	1.6	1080	3 HP HIGH SPEED			
2000							0.9	740	1.1	850	1.3	930	1.5	990	1.7	1050	1.9	1100				
2500							1.1	770	1.3	870	1.5	950	1.7	1010	1.9	1060	2.1	1110				
3000							1.1	650	1.4	800	1.6	890	1.8	960	2.0	1020	2.2	1080		2.4	1130	
3500							1.2	620	1.5	740	1.7	840	1.9	910	2.1	980	2.4	1040	2.6	1090	2.8	1140
3750	MOTOR WITH VFD	1.3	580	1.5	690	1.7	780	1.9	860	2.1	920	2.3	990	2.6	1040	2.8	1100	3.1	1150	5 HP MED SPEED		
4000		1.6	660	1.7	740	1.9	810	2.1	880	2.3	940	2.6	1000	2.8	1050	3.0	1110	3.3	1160			
4250		1.8	720	2.0	780	2.2	840	2.3	900	2.6	960	2.8	1010	3.0	1060	3.3	1120	3.6	1170			
4500	3 HP LOW SPEED	2.1	770	2.2	820	2.4	870	2.6	920	2.8	970	3.1	1030	3.3	1080	3.6	1130	3.9	1180	5 HP HIGH SPEED		
4750		2.4	810	2.5	850	2.7	900	2.9	950	3.1	990	3.3	1040	3.6	1090	3.9	1140	4.2	1190			
5000		2.7	850	2.8	890	3.0	930	3.2	970	3.4	1010	3.7	1060	3.9	1110	4.2	1150	4.5	1210			
5250	3.0	880	3.2	920	3.4	960	3.5	990	3.8	1030	4.0	1080	4.3	1120	4.6	1170	4.9	1220				
5500	5 HP LOW SPEED	3.4	910	3.5	950	3.7	980	3.9	1020	4.1	1060	4.4	1100	4.7	1140	5.0	1190	5.4	1240			
5750		3.8	950	3.9	980	4.1	1010	4.3	1040	4.5	1080	4.8	1120	5.1	1160	5.4	1200	5.8	1260			
6000		4.2	980	4.3	1000	4.5	1030	4.7	1070	5.0	1100	5.2	1140	5.5	1180	5.9	1220	6.3	1270			
6250		4.6	1000	4.8	1030	5.0	1060	5.2	1090	5.4	1120	5.7	1160	6.0	1190	6.3	1240	6.8	1290			
6500		5.1	1030	5.2	1060	5.4	1080	5.6	1110	5.9	1140	6.2	1170	6.5	1210	6.8	1250	7.3	1300			
6600		5.3	1040	5.4	1070	5.6	1090	5.8	1120	6.1	1150	6.4	1180	6.7	1220	7.0	1260	7.5	1310			
	7.5 HP LOW SPEED												7.5 HP MED SPEED									

Note: Airflow performance includes effect of clean, standard filter supplied with unit.





ENERGY RECOVERY VENTILATOR



ELECTRICAL DATA

Electrical Specifications				Motor Starters (Standard)			Optional IE3 Efficiency Motor with VFDs			Optional IE5+ Efficiency Motor with VFDs		
HP	Volts	HZ	Phase	FLA per Motor	Min. Cir. Amps	Max. Overcurrent Protection Device	FLA per Motor	Min. Cir. Amps	Max. Overcurrent Protection Device	FLA per Motor	Min. Cir. Amps	Max. Overcurrent Protection Device
3.0	208-230	60	Single	14.6-14.0	32.9	45.0	9.0-8.4	35.1	50.0	7.3-7.3	28.4	40.0
3.0	208-230	60	Three	9.0-8.4	20.3	25.0	9.0-8.4	20.3	25.0	7.3-7.3	16.4	20.0
	460	60	Three	4.2	9.5	15.0	4.2	9.5	15.0	3.7	8.3	15.0
	575	60	Three	3.3	7.4	15.0	3.3	7.4	15.0			
5.0	208-230	60	Three	13.9-13.4	31.3	45.0	13.9-13.4	31.3	45.0	10.5-10.5	23.6	30.0
	460	60	Three	6.7	15.1	20.0	6.7	15.1	20.0	5.3	11.9	15.0
	575	60	Three	5.3	11.9	15.0	5.3	11.9	15.0			
7.5	208-230	60	Three	20.0-19.0	45.0	60.0	20.0-19.0	45.0	60.0	17.4-17.4	39.2	50.0
	460	60	Three	9.5	21.4	30.0	9.5	21.4	30.0	8.7	19.6	25.0
	575	60	Three	7.6	17.1	20.0	7.6	17.1	20.0			

**LEGXINV ENERGY RECOVERY VENTILATOR**

**ABBREVIATIONS**  
 EA: Exhaust Air to outside  
 OA: Outside Air intake  
 RA: Room Air to be exhausted  
 FA: Fresh Air to inside

**INSTALLATION ORIENTATION**  
 Unit must be installed in orientation shown.

**NOTE**  
 1. UNLESS OTHERWISE SPECIFIED, DIMENSIONS ARE ROUNDED TO THE NEAREST EIGHTH OF AN INCH.  
 2. SPECIFICATIONS MAY BE SUBJECT TO CHANGE WITHOUT NOTICE.  
 3. MIN. DUCT CLEARANCE FROM DAMPER BLADES WHEN FULLY OPENED TO BE 2". SMACNA RULES APPLY.

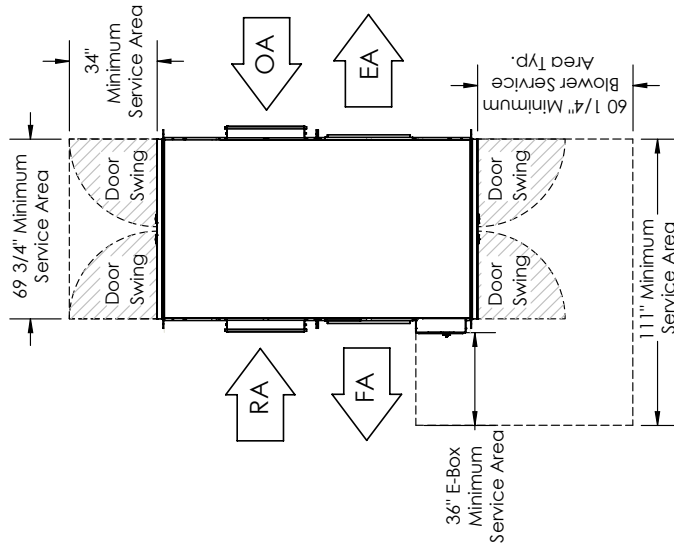

**TOP VIEW**

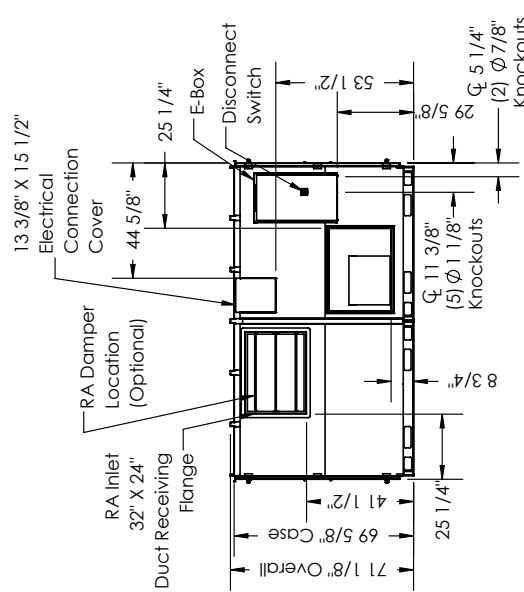

**LEFT VIEW**

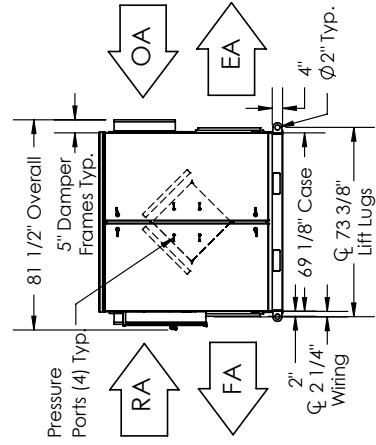

**FRONT VIEW**

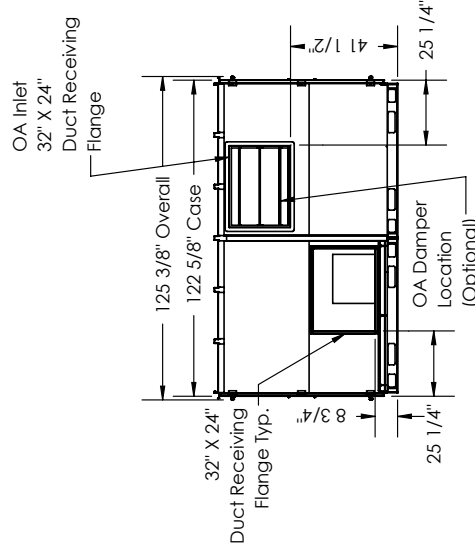

**RIGHT VIEW**

**UNIT MOUNTING & APPLICATION**  
 Must be mounted as shown. RA/EA airstream can be switched with OA/FA airstream unless certain options are selected.



**AIRFLOW ORIENTATION**  
 Available as shown.





ROOFTOP UNIT



LE10XRT shown

Energy recovery core is AHRI Certified®



SPECIFICATIONS

**Ventilation Type:** Static plate, heat and humidity transfer

**Typical Airflow Range:** 1,500–6,600 CFM

**AHRI 1060 Certified Core:** Six L125-G5

**Standard Features:**

- TEFC Premium efficiency motors
- Motor starters
- Non-fused disconnect
- 24VAC transformer/relay package
- Cross-core differential pressure ports
- Independent blower control

**Filters:** Total qty. 12, MERV 8: 20" x 25" x 2"

**Unit Weight:**

- Modular (per module) 1,069–1,461 lbs., varies by option(s)
- Assembled (1-piece) 2,086–2,753 lbs., varies by option(s)

**Max. Shipping Dimensions & Weight (on pallet):**

- Modular (2-modules) 80" L x 90" W x 78" H
- Module 1: 1,602 lbs., Module 2: 1,491 lbs.
- Assembled (1-piece) 160" L x 90" W x 78" H; 3,035 lbs.

**Motor(s):**

- Qty. 2, Belt drive blower/standard motor packages
- with choice of adjustable sheaves (see table below)

**Options:**

- Spring vibration isolators
- Ultra premium efficiency (IE5+) motors with variable frequency drives (VFDs): both airstreams
- Onboard VFDs: both airstreams
- Shaft grounding ring on motors with VFDs
- Fused disconnect
- Integrated programmable controls: enhanced, premium
- Class 1 low leakage motorized isolation dampers: FA, EA or both airstreams
- Factory mounted filter alarms: both airstreams
- Double wall construction
- Exterior paint - white, custom colors

**Accessories:**

- Filters: MERV 13, 2" (shipped loose)
- Automatic balancing damper: 4", 5", 6"
- Roof curb: standard 14"
- Curb wind clip
- Engineered combo curb for Carrier RTU
- Engineered combo curb for Trane RTU
- Digital time clock: wall mount (TC7D-W), in exterior enclosure (TC7D-E)
- Carbon dioxide sensor/control wall mount (CO2-W), duct mount (CO2-D)
- IAQ sensor: wall mount (IAQ-W), duct mount (IAQ-D)
- Motion occupancy sensor/control: ceiling mount (MC-C), wall mount (MC-W)
- Smoke Detector: duct mount (SD-D)
- BACnet fan control: wall mount (BACNETFC-W)
- Indoor electric duct heater: EK series (1–175 kW);
- Indirect gas-fired duct furnace: GH series (50–400 MBH); installed downstream of any fans

AIRFLOW PERFORMANCE

Airflow CFM	External Static Pressure (in.w.g.)																					
	0.00		0.25		0.50		0.75		1.00		1.25		1.50		1.75		2.00					
	BHP	RPM	BHP	RPM	BHP	RPM	BHP	RPM	BHP	RPM	BHP	RPM	BHP	RPM	BHP	RPM	BHP	RPM				
					MOTOR WITH VFD				3 HP LOW SPEED				3 HP MED SPEED				3 HP HIGH SPEED					
1500					0.7	640	0.7	750	0.9	840	1.1	920	1.5	990	1.9	1060	2.4	1120				
2000					0.8	670	0.9	770	1.1	860	1.4	940	1.7	1010	2.2	1080	2.6	1140				
2500			0.9	600	0.9	710	1.1	800	1.3	880	1.7	950	2.0	1030	2.4	1090	2.9	1150				
3000	MOTOR WITH VFD	1.0	570	1.1	660	1.2	750	1.4	830	1.7	900	2.0	970	2.3	1040	2.7	1110	3.1	1170	5 HP MED SPEED		
3500		1.2	650	1.4	730	1.6	800	1.8	870	2.1	930	2.4	1000	2.7	1060	3.1	1120	3.5	1190	5 HP HIGH SPEED		
3750		1.4	690	1.6	760	1.8	820	2.0	890	2.3	950	2.6	1010	2.9	1070	3.3	1130	3.7	1190			
4000		1.6	730	1.8	790	2.0	850	2.3	910	2.5	970	2.8	1030	3.2	1090	3.5	1150	3.9	1200			
4250	3 HP LOW SPEED	1.9	770	2.1	820	2.3	880	2.5	930	2.8	990	3.1	1040	3.4	1100	3.7	1160	4.1	1210		5 HP HIGH SPEED	
4500		2.2	800	2.4	850	2.6	900	2.8	960	3.1	1010	3.4	1060	3.7	1110	4.0	1170	4.3	1230			
4750		2.5	840	2.7	880	2.9	930	3.1	980	3.4	1030	3.7	1080	4.0	1130	4.3	1180	4.6	1240			
5000	5 HP LOW SPEED	2.8	870	3.0	910	3.2	960	3.5	1000	3.7	1050	4.0	1100	4.3	1150	4.6	1200	4.9	1250	5 HP HIGH SPEED		
5250		3.2	910	3.4	940	3.6	990	3.8	1030	4.1	1070	4.3	1120	4.6	1170	4.9	1220	5.3	1270			
5500		3.6	940	3.8	970	4.0	1010	4.2	1050	4.5	1090	4.7	1140	5.0	1180	5.3	1230	5.6	1290			
5750		4.0	970	4.2	1000	4.4	1040	4.6	1080	4.9	1120	5.1	1160	5.4	1200	5.7	1250	6.0	1300			
6000		4.4	1000	4.6	1030	4.8	1070	5.0	1100	5.3	1140	5.5	1180	5.8	1230	6.1	1270	6.4	1330			
6250	7.5 HP LOW SPEED	4.9	1030	5.1	1060	5.3	1090	5.5	1130	5.7	1160	6.0	1200	6.2	1250	6.5	1300	6.9	1350	7.5 HP MED SPEED		
6500		5.3	1060	5.5	1090	5.7	1120	6.0	1150	6.2	1190	6.4	1230	6.7	1270	7.0	1320	7.4	1380			
6600		5.5	1070	5.7	1100	5.9	1130	6.1	1160	6.4	1200	6.6	1240	6.9	1280	7.2	1330	7.5	1390			

Note: Airflow performance includes effect of clean, standard filter supplied with unit.





ENERGY RECOVERY VENTILATOR



ELECTRICAL DATA

Electrical Specifications				Motor Starters (Standard)			Optional IE3 Efficiency Motor with VFDs			Optional IE5+ Efficiency Motor with VFDs		
HP	Volts	HZ	Phase	FLA per Motor	Min. Cir. Amps	Max. Overcurrent Protection Device	FLA per Motor	Min. Cir. Amps	Max. Overcurrent Protection Device	FLA per Motor	Min. Cir. Amps	Max. Overcurrent Protection Device
3.0	208-230	60	Single	14.6-14.0	32.9	45.0	9.0-8.4	35.1	50.0	7.3-7.3	28.4	40.0
3.0	208-230	60	Three	9.0-8.4	20.3	25.0	9.0-8.4	20.3	25.0	7.3-7.3	16.4	20.0
	460	60	Three	4.2	9.5	15.0	4.2	9.5	15.0	3.7	8.3	15.0
	575	60	Three	3.3	7.4	15.0	3.3	7.4	15.0			
5.0	208-230	60	Three	13.9-13.4	31.3	45.0	13.9-13.4	31.3	45.0	10.5-10.5	23.6	30.0
	460	60	Three	6.7	15.1	20.0	6.7	15.1	20.0	5.3	11.9	15.0
	575	60	Three	5.3	11.9	15.0	5.3	11.9	15.0			
7.5	208-230	60	Three	20.0-19.0	45.0	60.0	20.0-19.0	45.0	60.0	17.4-17.4	39.2	50.0
	460	60	Three	9.5	21.4	30.0	9.5	21.4	30.0	8.7	19.6	25.0
	575	60	Three	7.6	17.1	20.0	7.6	17.1	20.0			

**LEGXRT (RTV/RTR) ENERGY RECOVERY VENTILATOR**

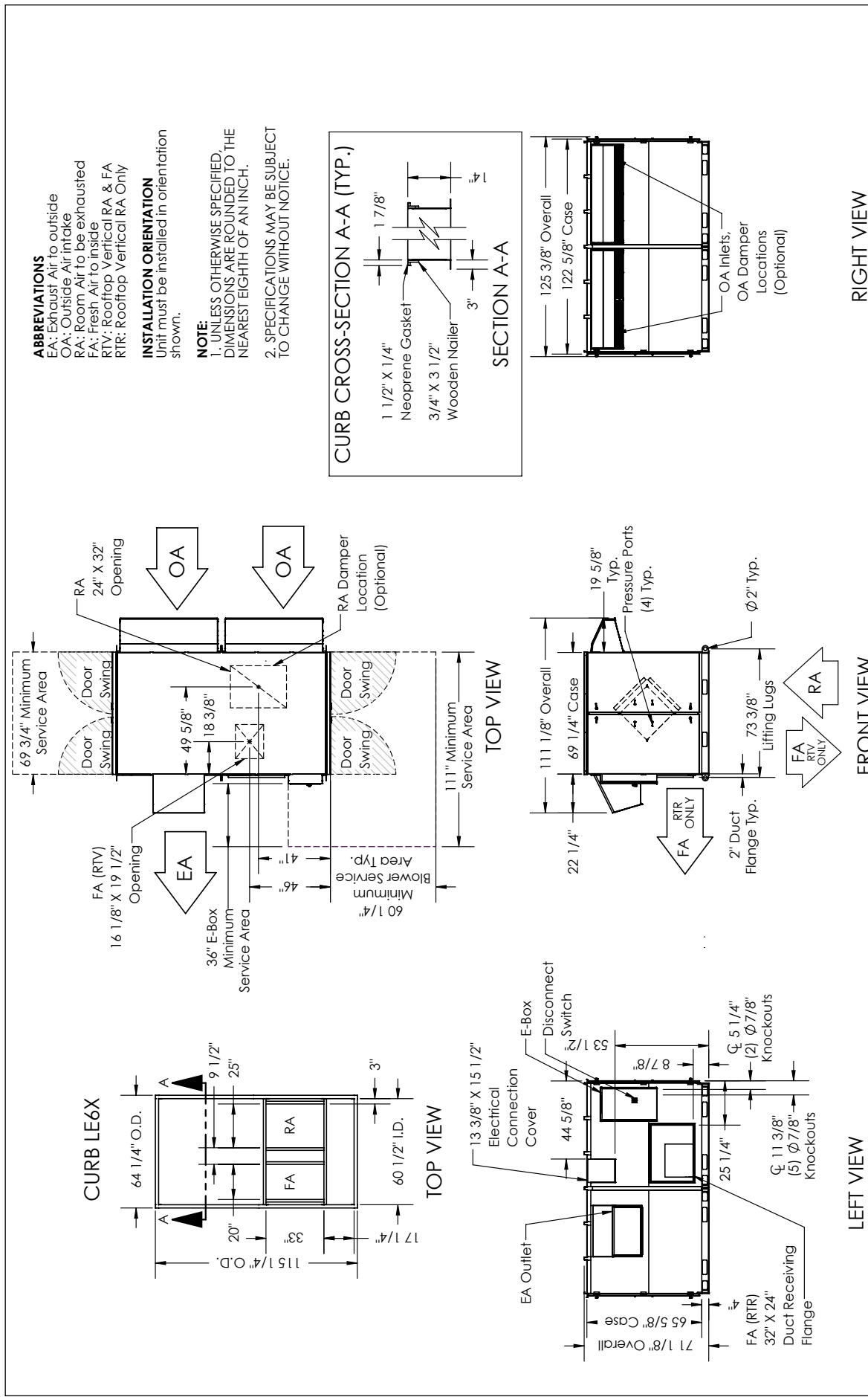

**UNIT MOUNTING & APPLICATION**  
 Must be mounted as shown. Airstreams cannot be switched.

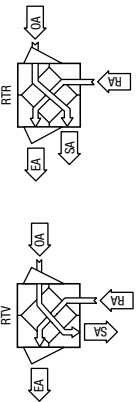



ENERGY RECOVERY VENTILATOR



ROOFTOP UNIT



LE8XINV shown

SPECIFICATIONS

**Ventilation Type:** Static plate, heat and humidity transfer

**Typical Airflow Range:** 2,000–8,800 CFM

**AHRI 1060 Certified Core:** Eight L125-G5

**Standard Features:**

- TEFC Premium efficiency motors
- Motor starters
- Non-fused disconnect
- 24VAC transformer/relay package
- Cross-core differential pressure ports
- Independent blower control

**Filters:** Total qty. 16, MERV 8: 20" x 25" x 2"

**Unit Weight:**

- Modular (2-modules) 918–1,984 lbs., varies by option(s)
- Assembled (1-piece) 2,495–3,295 lbs., varies by option(s)

**Max. Shipping Dimensions & Weight (on pallet):**

- Modular (2-modules) 100" L x 90" W x 78" H
- Module 1: 2,164 lbs., Module 2: 1,493 lbs.
- Assembled (1-piece) 200" L x 90" W x 78" H; 3,654 lbs.

**Motor(s):**

- Qty. 2, Belt drive blower/standard motor packages with choice of adjustable sheaves (see table below)

**Options:**

- Spring vibration isolators
- Ultra premium efficiency (IE5+) motors with variable frequency drives (VFDs): both airstreams
- Onboard VFDs: both airstreams
- Shaft grounding ring on motors with VFDs
- Fused disconnect
- Integrated programmable controls: enhanced, premium
- Class 1 low leakage motorized isolation dampers: FA, EA or both airstreams
- Factory mounted filter alarms: both airstreams
- Double wall construction
- Exterior paint - white, custom colors

**Accessories:**

- Filters: MERV 13, 2" (shipped loose)
- Automatic balancing damper: 4", 5", 6"
- Digital time clock: wall mount (TC7D-W), in exterior enclosure (TC7D-E)
- Carbon dioxide sensor/control wall mount (CO2-W), duct mount (CO2-D)
- IAQ sensor: wall mount (IAQ-W), duct mount (IAQ-D)
- Motion occupancy sensor/control: ceiling mount (MC-C), wall mount (MC-W)
- Smoke Detector: duct mount (SD-D)
- BACnet fan control: wall mount (BACNETFC-W)
- Indoor electric duct heater: EK series (1–175 kW);
- Indirect gas-fired duct furnace: GH series (50–400 MBH); Installed downstream of any fans

Energy recovery core is AHRI Certified®



AIRFLOW PERFORMANCE

Airflow CFM		External Static Pressure (in.w.g.)																	
		0.00		0.25		0.50		0.75		1.00		1.25		1.50		1.75		2.00	
		BHP	RPM	BHP	RPM	BHP	RPM	BHP	RPM	BHP	RPM	BHP	RPM	BHP	RPM	BHP	RPM	BHP	RPM
						MOTOR WITH VFD		3 HP LOW SPEED				3 HP MED SPEED		3 HP HIGH SPEED					
2000						0.6	530	1.0	680	1.3	790	1.5	870	1.8	940	2.0	1000	2.2	1060
3000	MOTOR WITH VFD	0.3	300	0.8	520	1.1	640	1.4	740	1.7	820	2.0	890	2.3	960	2.6	1020	2.9	1070
4000		0.9	520	1.2	620	1.6	710	1.9	790	2.2	860	2.6	920	2.9	990	3.2	1040	3.6	1100
4500		1.2	570	1.5	660	1.8	740	2.2	810	2.5	880	2.9	940	3.2	1000	3.6	1060	4.0	1110
5000		1.4	610	1.7	690	2.1	770	2.5	840	2.8	900	3.2	960	3.6	1020	4.0	1070	4.5	1130
5500	3 HP LOW SPEED	1.7	650	2.0	730	2.4	800	2.8	860	3.2	930	3.6	980	4.0	1040	4.5	1090	4.9	1140
6000		1.9	690	2.3	760	2.7	830	3.1	890	3.6	950	4.0	1010	4.5	1060	5.0	1110	5.5	1160
6250		2.1	710	2.5	780	2.9	840	3.3	910	3.8	960	4.3	1020	4.7	1070	5.2	1120	5.7	1170
6500		2.3	720	2.7	790	3.1	860	3.6	920	4.0	980	4.5	1030	5.0	1080	5.5	1130	6.0	1180
6750		2.4	740	2.9	810	3.3	870	3.8	930	4.3	990	4.8	1040	5.3	1100	5.8	1140	6.3	1190
7000		2.6	760	3.1	830	3.5	890	4.0	950	4.5	1000	5.0	1060	5.6	1110	6.1	1160	6.6	1200
7250	5 HP LOW SPEED	2.8	780	3.3	850	3.7	910	4.3	960	4.8	1020	5.3	1070	5.8	1120	6.4	1170	7.0	1210
7500		3.0	800	3.5	860	4.0	920	4.5	980	5.0	1030	5.6	1080	6.2	1130	6.7	1180	7.3	1220
7750		3.2	820	3.7	880	4.2	940	4.8	990	5.3	1050	5.9	1100	6.5	1140	7.1	1190	7.6	1230
8000		3.5	840	4.0	900	4.5	960	5.1	1010	5.6	1060	6.2	1110	6.8	1160	7.4	1200	8.0	1240
8250		3.7	860	4.2	920	4.8	970	5.4	1030	5.9	1080	6.5	1120	7.1	1170	7.7	1210	8.4	1250
8500		4.0	880	4.5	930	5.1	990	5.7	1040	6.3	1090	6.9	1140	7.5	1180	8.1	1220		
8800	4.3	900	4.9	960	5.5	1010	6.1	1060	6.7	1110	7.3	1150	7.9	1200	8.6	1240			
						5 HP MED SPEED		7.5 HP LOW SPEED		7.5 HP MED SPEED				7.5 HP + SERVICE FACTOR HIGH SPEED					

Note: Airflow performance includes effect of clean, standard filter supplied with unit.







ENERGY RECOVERY VENTILATOR



ELECTRICAL DATA

Electrical Specifications				Motor Starters (Standard)			Optional IE3 Efficiency Motor with VFDs			Optional IE5+ Efficiency Motor with VFDs		
HP	Volts	HZ	Phase	FLA per Motor	Min. Cir. Amps	Max. Overcurrent Protection Device	FLA per Motor	Min. Cir. Amps	Max. Overcurrent Protection Device	FLA per Motor	Min. Cir. Amps	Max. Overcurrent Protection Device
3.0	208-230	60	Single	14.6-14.0	32.9	45.0	9.0-8.4	35.1	50.0	7.3-7.3	28.4	40.0
3.0	208-230	60	Three	9.0-8.4	20.3	25.0	9.0-8.4	20.3	25.0	7.3-7.3	16.4	20.0
	460	60	Three	4.2	9.5	15.0	4.2	9.5	15.0	3.7	8.3	15.0
	575	60	Three	3.3	7.4	15.0	3.3	7.4	15.0			
5.0	208-230	60	Three	13.9-13.4	31.3	45.0	13.9-13.4	31.3	45.0	10.5-10.5	23.6	30.0
	460	60	Three	6.7	15.1	20.0	6.7	15.1	20.0	5.3	11.9	15.0
	575	60	Three	5.3	11.9	15.0	5.3	11.9	15.0			
7.5	208-230	60	Three	20.0-19.0	45.0	60.0	20.0-19.0	45.0	60.0	17.4-17.4	39.2	50.0
	460	60	Three	9.5	21.4	30.0	9.5	21.4	30.0	8.7	19.6	25.0
	575	60	Three	7.6	17.1	20.0	7.6	17.1	20.0			

**LE8XINH ENERGY RECOVERY VENTILATOR**

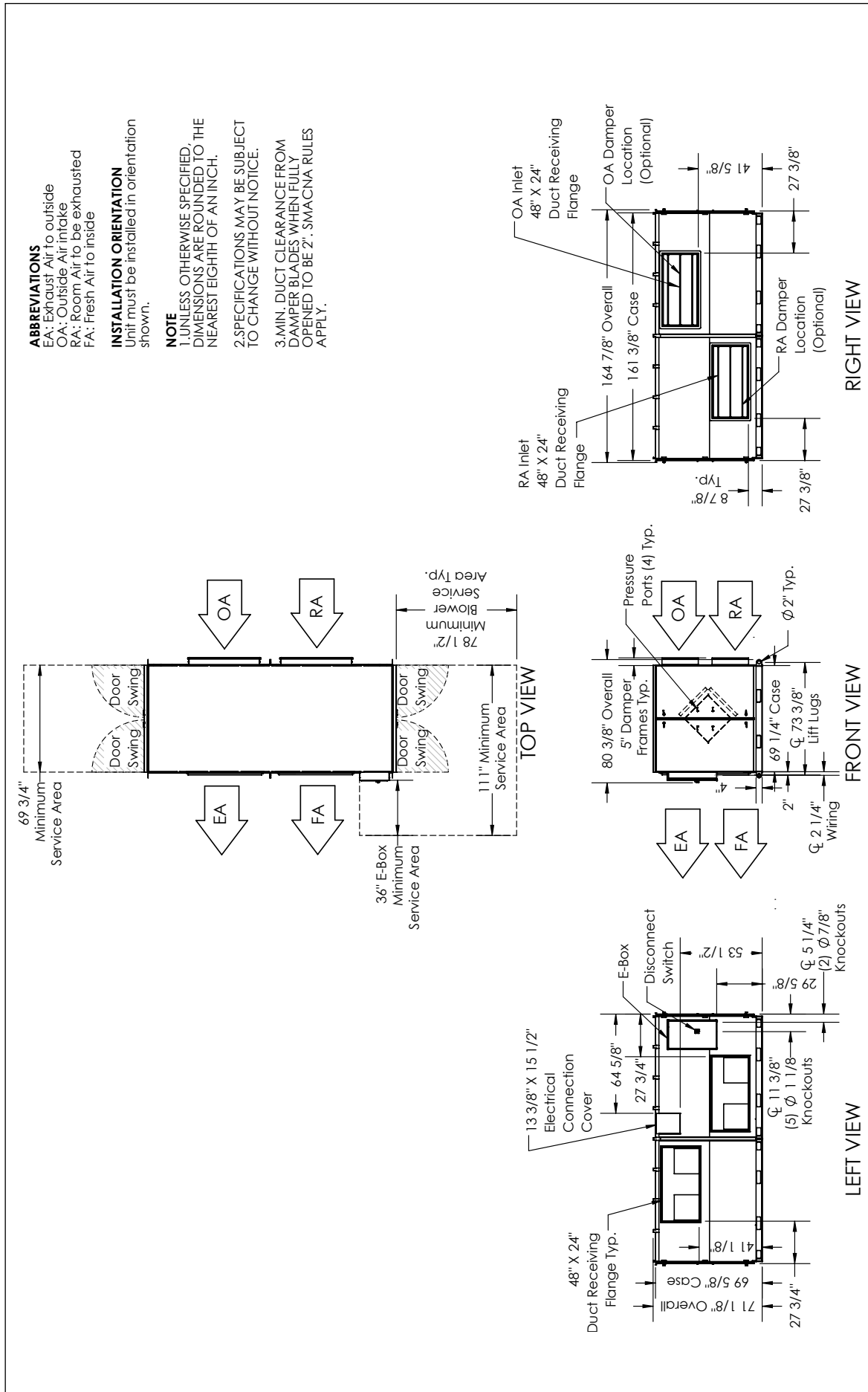

**ABBREVIATIONS**

- EA: Exhaust Air To outside
- OA: Outside Air Intake
- RA: Room Air to be exhausted
- FA: Fresh Air to inside

**INSTALLATION ORIENTATION**

Unit must be installed in orientation shown.

**NOTE**

1. UNLESS OTHERWISE SPECIFIED, DIMENSIONS ARE ROUNDED TO THE NEAREST EIGHTH OF AN INCH.
2. SPECIFICATIONS MAY BE SUBJECT TO CHANGE WITHOUT NOTICE.
3. MIN. DUCT CLEARANCE FROM DAMPER BLADES WHEN FULLY OPENED TO BE 2". SMACNA RULES APPLY.

**UNIT MOUNTING & APPLICATION**



Must be mounted as shown. RA/EA airstream can be switched with OA/FA airstream unless certain options are selected.

**AIRFLOW ORIENTATION**

Available as shown.





ENERGY RECOVERY VENTILATOR



ROOFTOP UNIT



LE8XINV shown

SPECIFICATIONS

**Ventilation Type:** Static plate, heat and humidity transfer

**Typical Airflow Range:** 2,000–8,800 CFM

**AHRI 1060 Certified Core:** Eight L125-G5

**Standard Features:**

- TEFC Premium efficiency motors
- Motor starters
- Non-fused disconnect
- 24VAC transformer/relay package
- Cross-core differential pressure ports
- Independent blower control

**Filters:** Total qty. 16, MERV 8: 20" x 25" x 2"

**Unit Weight:**

- Modular (2-modules) 918–1,984 lbs., varies by option(s)
- Assembled (1-piece) 2,495–3,295 lbs., varies by option(s)

**Max. Shipping Dimensions & Weight (on pallet):**

- Modular (2-modules) 100" L x 90" W x 78" H
- Module 1: 2,164 lbs., Module 2: 1,493 lbs.
- Assembled (1-piece) 200" L x 90" W x 78" H; 3,654 lbs.

**Motor(s):**

- Qty. 2, Belt drive blower/standard motor packages with choice of adjustable sheaves (see table below)

**Options:**

- Spring vibration isolators
- Ultra premium efficiency (IE5+) motors with variable frequency drives (VFDs): both airstreams
- Onboard VFDs: both airstreams
- Shaft grounding ring on motors with VFDs
- Fused disconnect
- Integrated programmable controls: enhanced, premium
- Class 1 low leakage motorized isolation dampers: FA, EA or both airstreams
- Factory mounted filter alarms: both airstreams
- Double wall construction
- Exterior paint - white, custom colors

**Accessories:**

- Filters: MERV 13, 2" (shipped loose)
- Automatic balancing damper: 4", 5", 6"
- Digital time clock: wall mount (TC7D-W), in exterior enclosure (TC7D-E)
- Carbon dioxide sensor/control wall mount (CO2-W), duct mount (CO2-D)
- IAQ sensor: wall mount (IAQ-W), duct mount (IAQ-D)
- Motion occupancy sensor/control: ceiling mount (MC-C), wall mount (MC-W)
- Smoke Detector: duct mount (SD-D)
- BACnet fan control: wall mount (BACNETFC-W)
- Indoor electric duct heater: EK series (1–175 kW);
- Indirect gas-fired duct furnace: GH series (50–400 MBH); Installed downstream of any fans

Energy recovery core is AHRI Certified®



AIRFLOW PERFORMANCE

Airflow CFM		External Static Pressure (in.w.g.)																	
		0.00		0.25		0.50		0.75		1.00		1.25		1.50		1.75		2.00	
		BHP	RPM	BHP	RPM	BHP	RPM	BHP	RPM	BHP	RPM	BHP	RPM	BHP	RPM	BHP	RPM	BHP	RPM
						MOTOR WITH VFD		3 HP LOW SPEED				3 HP MED SPEED		3 HP HIGH SPEED					
2000						0.6	530	1.0	680	1.3	790	1.5	870	1.8	940	2.0	1000	2.2	1060
3000	MOTOR WITH VFD	0.3	300	0.8	520	1.1	640	1.4	740	1.7	820	2.0	890	2.3	960	2.6	1020	2.9	1070
4000		0.9	520	1.2	620	1.6	710	1.9	790	2.2	860	2.6	920	2.9	990	3.2	1040	3.6	1100
4500		1.2	570	1.5	660	1.8	740	2.2	810	2.5	880	2.9	940	3.2	1000	3.6	1060	4.0	1110
5000		1.4	610	1.7	690	2.1	770	2.5	840	2.8	900	3.2	960	3.6	1020	4.0	1070	4.5	1130
5500	3 HP LOW SPEED	1.7	650	2.0	730	2.4	800	2.8	860	3.2	930	3.6	980	4.0	1040	4.5	1090	4.9	1140
6000		1.9	690	2.3	760	2.7	830	3.1	890	3.6	950	4.0	1010	4.5	1060	5.0	1110	5.5	1160
6250		2.1	710	2.5	780	2.9	840	3.3	910	3.8	960	4.3	1020	4.7	1070	5.2	1120	5.7	1170
6500		2.3	720	2.7	790	3.1	860	3.6	920	4.0	980	4.5	1030	5.0	1080	5.5	1130	6.0	1180
6750		2.4	740	2.9	810	3.3	870	3.8	930	4.3	990	4.8	1040	5.3	1100	5.8	1140	6.3	1190
7000		2.6	760	3.1	830	3.5	890	4.0	950	4.5	1000	5.0	1060	5.6	1110	6.1	1160	6.6	1200
7250	5 HP LOW SPEED	2.8	780	3.3	850	3.7	910	4.3	960	4.8	1020	5.3	1070	5.8	1120	6.4	1170	7.0	1210
7500		3.0	800	3.5	860	4.0	920	4.5	980	5.0	1030	5.6	1080	6.2	1130	6.7	1180	7.3	1220
7750		3.2	820	3.7	880	4.2	940	4.8	990	5.3	1050	5.9	1100	6.5	1140	7.1	1190	7.6	1230
8000		3.5	840	4.0	900	4.5	960	5.1	1010	5.6	1060	6.2	1110	6.8	1160	7.4	1200	8.0	1240
8250		3.7	860	4.2	920	4.8	970	5.4	1030	5.9	1080	6.5	1120	7.1	1170	7.7	1210	8.4	1250
8500		4.0	880	4.5	930	5.1	990	5.7	1040	6.3	1090	6.9	1140	7.5	1180	8.1	1220		
8800	4.3	900	4.9	960	5.5	1010	6.1	1060	6.7	1110	7.3	1150	7.9	1200	8.6	1240			
						5 HP MED SPEED		7.5 HP LOW SPEED		7.5 HP MED SPEED				7.5 HP + SERVICE FACTOR HIGH SPEED					

Note: Airflow performance includes effect of clean, standard filter supplied with unit.





ENERGY RECOVERY VENTILATOR



ELECTRICAL DATA

Electrical Specifications				Motor Starters (Standard)			Optional IE3 Efficiency Motor with VFDs			Optional IE5+ Efficiency Motor with VFDs		
HP	Volts	HZ	Phase	FLA per Motor	Min. Cir. Amps	Max. Overcurrent Protection Device	FLA per Motor	Min. Cir. Amps	Max. Overcurrent Protection Device	FLA per Motor	Min. Cir. Amps	Max. Overcurrent Protection Device
3.0	208-230	60	Single	14.6-14.0	32.9	45.0	9.0-8.4	35.1	50.0	7.3-7.3	28.4	40.0
3.0	208-230	60	Three	9.0-8.4	20.3	25.0	9.0-8.4	20.3	25.0	7.3-7.3	16.4	20.0
	460	60	Three	4.2	9.5	15.0	4.2	9.5	15.0	3.7	8.3	15.0
	575	60	Three	3.3	7.4	15.0	3.3	7.4	15.0			
5.0	208-230	60	Three	13.9-13.4	31.3	45.0	13.9-13.4	31.3	45.0	10.5-10.5	23.6	30.0
	460	60	Three	6.7	15.1	20.0	6.7	15.1	20.0	5.3	11.9	15.0
	575	60	Three	5.3	11.9	15.0	5.3	11.9	15.0			
7.5	208-230	60	Three	20.0-19.0	45.0	60.0	20.0-19.0	45.0	60.0	17.4-17.4	39.2	50.0
	460	60	Three	9.5	21.4	30.0	9.5	21.4	30.0	8.7	19.6	25.0
	575	60	Three	7.6	17.1	20.0	7.6	17.1	20.0			

**LE8XINV ENERGY RECOVERY VENTILATOR**

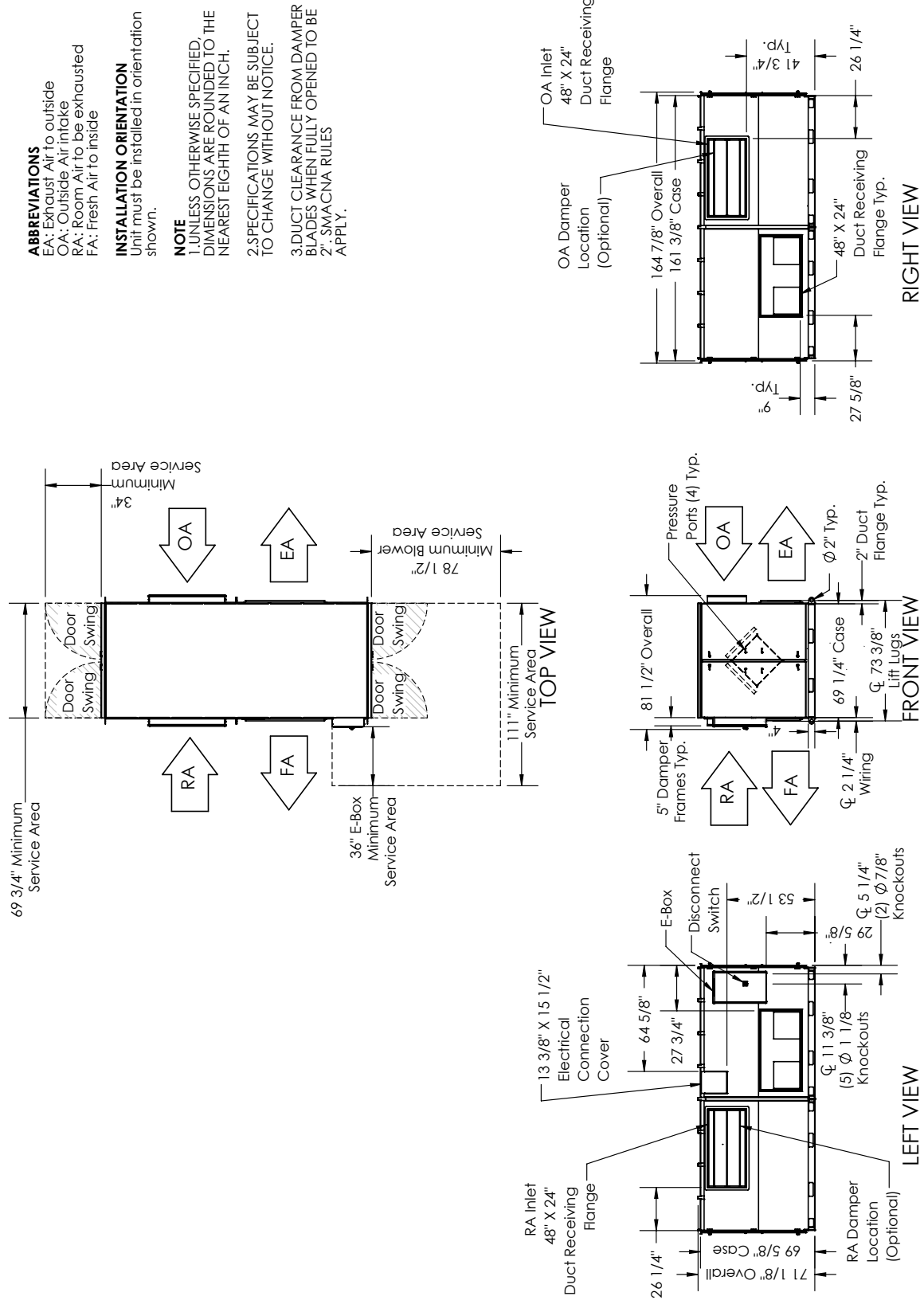

**ABBREVIATIONS**

- EA: Exhaust Air to outside
- OA: Outside Air intake
- RA: Room Air to be exhausted
- FA: Fresh Air to inside

**INSTALLATION ORIENTATION**

Unit must be installed in orientation shown.

**NOTE**

1. UNLESS OTHERWISE SPECIFIED, DIMENSIONS ARE ROUNDED TO THE NEAREST EIGHTH OF AN INCH.
2. SPECIFICATIONS MAY BE SUBJECT TO CHANGE WITHOUT NOTICE.
3. DUCT CLEARANCE FROM DAMPER BLADES WHEN FULLY OPENED TO BE 2" - SMACNA RULES APPLY.

**UNIT MOUNTING & APPLICATION**

Must be mounted as shown. RA/EA airstream can be switched with OA/FA airstream unless certain options are selected.



**AIRFLOW ORIENTATION**

Available as shown.





ENERGY RECOVERY VENTILATOR



ROOFTOP UNIT



LE10XRT shown

Energy recovery core is AHRI Certified®



SPECIFICATIONS

**Ventilation Type:** Static plate, heat and humidity transfer

**Typical Airflow Range:** 2,000–8,800 CFM

**AHRI 1060 Certified Core:** Six L125-G5

**Standard Features:**

- TEFC Premium efficiency motors
- Motor starters
- Non-fused disconnect
- 24VAC transformer/relay package
- Cross-core differential pressure ports
- Independent blower control

**Filters:** Total qty. 12, MERV 8: 20" x 25" x 2"

**Unit Weight:**

Modular (per module) 1,311–1,806 lbs., varies by option(s)

Assembled (1-piece) 2,631–3,453 lbs., varies by option(s)

**Max. Shipping Dimensions & Weight (on pallet):**

Modular (2-modules) 80" L x 90" W x 78" H

Module 1: 1,986 lbs., Module 2: 1,917 lbs.

Assembled (1-piece) 200" L x 90" W x 78" H; 3,812 lbs.

**Motor(s):**

Qty. 2, Belt drive blower/standard motor packages with choice of adjustable sheaves (see table below)

**Options:**

- Spring vibration isolators
- Ultra premium efficiency (IE5+) motors with variable frequency drives (VFDs): both airstreams
- Onboard VFDs: both airstreams
- Shaft grounding ring on motors with VFDs
- Fused disconnect
- Integrated programmable controls: enhanced, premium
- Class 1 low leakage motorized isolation dampers: FA, EA or both airstreams
- Factory mounted filter alarms: both airstreams
- Double wall construction
- Exterior paint - white, custom colors

**Accessories:**

- Filters: MERV 13, 2" (shipped loose)
- Automatic balancing damper: 4", 5", 6"
- Roof curb: standard 14"
- Curb wind clip
- Engineered combo curb for Carrier RTU
- Engineered combo curb for Trane RTU
- Digital time clock: wall mount (TC7D-W), in exterior enclosure (TC7D-E)
- Carbon dioxide sensor/control wall mount (CO2-W), duct mount (CO2-D)
- IAQ sensor: wall mount (IAQ-W), duct mount (IAQ-D)
- Motion occupancy sensor/control: ceiling mount (MC-C), wall mount (MC-W)
- Smoke Detector: duct mount (SD-D)
- BACnet fan control: wall mount (BACNETFC-W)
- Indoor electric duct heater: EK series (1–175 kW);
- Indirect gas-fired duct furnace: GH series (50–400 MBH); installed downstream of any fans

AIRFLOW PERFORMANCE

Airflow CFM		External Static Pressure (in.w.g.)																		
		0.00		0.25		0.50		0.75		1.00		1.25		1.50		1.75			2.00	
		BHP	RPM	BHP	RPM	BHP	RPM	BHP	RPM	BHP	RPM	BHP	RPM	BHP	RPM	BHP	RPM		BHP	RPM
						3 HP LOW SPEED				3 HP MEDIUM SPEED		3 HP HIGH SPEED								
2000						1.3	640	1.3	730	1.4	810	1.6	890	1.9	960	2.4	1030	2.9	1100	
3000		1.5		600	1.5	700	1.6	780	1.9	860	2.2	930	2.7	1000	3.1	1060	3.7	1130	5 HP HIGH SPEED	
4000	MOTOR WITH VFD	1.5	580	1.6	680	1.9	760	2.2	840	2.6	910	3.0	980	3.5	1040	4.0	1100	4.6	1160	5 HP HIGH SPEED
4500		1.6	620	1.8	710	2.1	800	2.5	870	3.0	940	3.5	1010	4.0	1060	4.5	1120	5.1	1170	7.5 HP MED SPEED
5000	3 HP LOW SPEED	1.7	660	2.1	750	2.5	830	3.0	910	3.5	970	4.0	1030	4.5	1090	5.1	1140	5.6	1190	7.5 HP HIGH SPEED
5500		2.0	710	2.4	790	2.9	870	3.4	940	4.0	1000	4.5	1060	5.1	1110	5.6	1160	6.2	1210	
6000		2.4	750	2.9	840	3.4	910	4.0	970	4.5	1030	5.1	1090	5.7	1140	6.2	1190	6.8	1230	
6250		2.6	780	3.1	860	3.7	930	4.2	990	4.8	1050	5.4	1100	6.0	1150	6.5	1200	7.1	1240	
6500	5 HP LOW SPEED	2.8	800	3.4	880	4.0	950	4.5	1010	5.1	1060	5.7	1110	6.3	1160	6.8	1210	7.4	1250	7.5 HP + SERVICE FACTOR HIGH SPEED
6750		3.1	820	3.7	900	4.3	960	4.8	1020	5.4	1080	6.0	1130	6.6	1180	7.2	1220	7.7	1260	
7000		3.3	850	4.0	920	4.6	980	5.2	1040	5.8	1090	6.3	1140	6.9	1190	7.5	1230	8.0	1270	
7250	5 HP MED SPEED	3.6	870	4.3	940	4.9	1000	5.5	1060	6.1	1110	6.7	1160	7.2	1200	7.8	1240	8.4	1280	
7500		3.9	900	4.6	960	5.2	1020	5.8	1080	6.4	1120	7.0	1170	7.6	1210	8.2	1250			
7750	7.5 HP LOW SPEED	4.3	920	4.9	980	5.6	1040	6.2	1090	6.8	1140	7.4	1180	7.9	1230	8.5	1270			
8000		4.6	940	5.3	1000	5.9	1060	6.5	1110	7.1	1160	7.7	1200	8.3	1240					
8250		5.0	970	5.7	1020	6.3	1080	6.9	1130	7.5	1170	8.1	1210	8.6	1250					
8500	7.5 HP LOW SPEED	5.4	990	6.0	1050	6.7	1100	7.3	1140	7.9	1190	8.4	1230							
8800		5.9	1020	6.5	1070	7.1	1120	7.7	1160	8.3	1200									
		7.5 HP MED SPEED								7.5 HP + SERVICE FACTOR HIGH SPEED										

Note: Airflow performance includes effect of clean, standard filter supplied with unit.





ENERGY RECOVERY VENTILATOR



ELECTRICAL DATA

Electrical Specifications				Motor Starters (Standard)			Optional IE3 Efficiency Motor with VFDs			Optional IE5+ Efficiency Motor with VFDs		
HP	Volts	HZ	Phase	FLA per Motor	Min. Cir. Amps	Max. Overcurrent Protection Device	FLA per Motor	Min. Cir. Amps	Max. Overcurrent Protection Device	FLA per Motor	Min. Cir. Amps	Max. Overcurrent Protection Device
3.0	208-230	60	Single	14.6-14.0	32.9	45.0	9.0-8.4	35.1	50.0	7.3-7.3	28.4	40.0
3.0	208-230	60	Three	9.0-8.4	20.3	25.0	9.0-8.4	20.3	25.0	7.3-7.3	16.4	20.0
	460	60	Three	4.2	9.5	15.0	4.2	9.5	15.0	3.7	8.3	15.0
	575	60	Three	3.3	7.4	15.0	3.3	7.4	15.0			
5.0	208-230	60	Three	13.9-13.4	31.3	45.0	13.9-13.4	31.3	45.0	10.5-10.5	23.6	30.0
	460	60	Three	6.7	15.1	20.0	6.7	15.1	20.0	5.3	11.9	15.0
	575	60	Three	5.3	11.9	15.0	5.3	11.9	15.0			
7.5	208-230	60	Three	20.0-19.0	45.0	60.0	20.0-19.0	45.0	60.0	17.4-17.4	39.2	50.0
	460	60	Three	9.5	21.4	30.0	9.5	21.4	30.0	8.7	19.6	25.0
	575	60	Three	7.6	17.1	20.0	7.6	17.1	20.0			

**LE8XRT (RTH/RTF) ENERGY RECOVERY VENTILATOR**

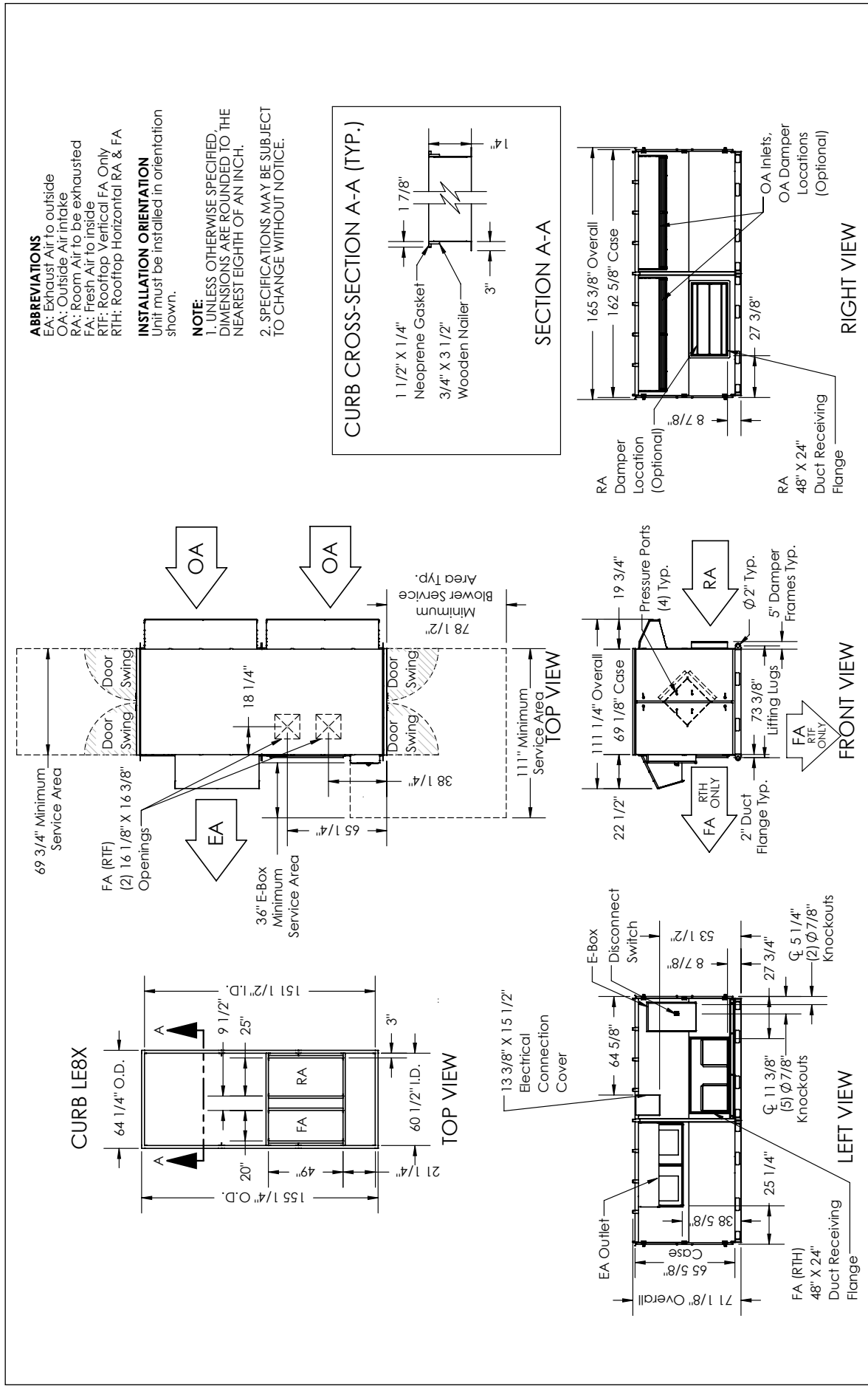



**LE8XRT (RTV/RTR) ENERGY RECOVERY VENTILATOR**

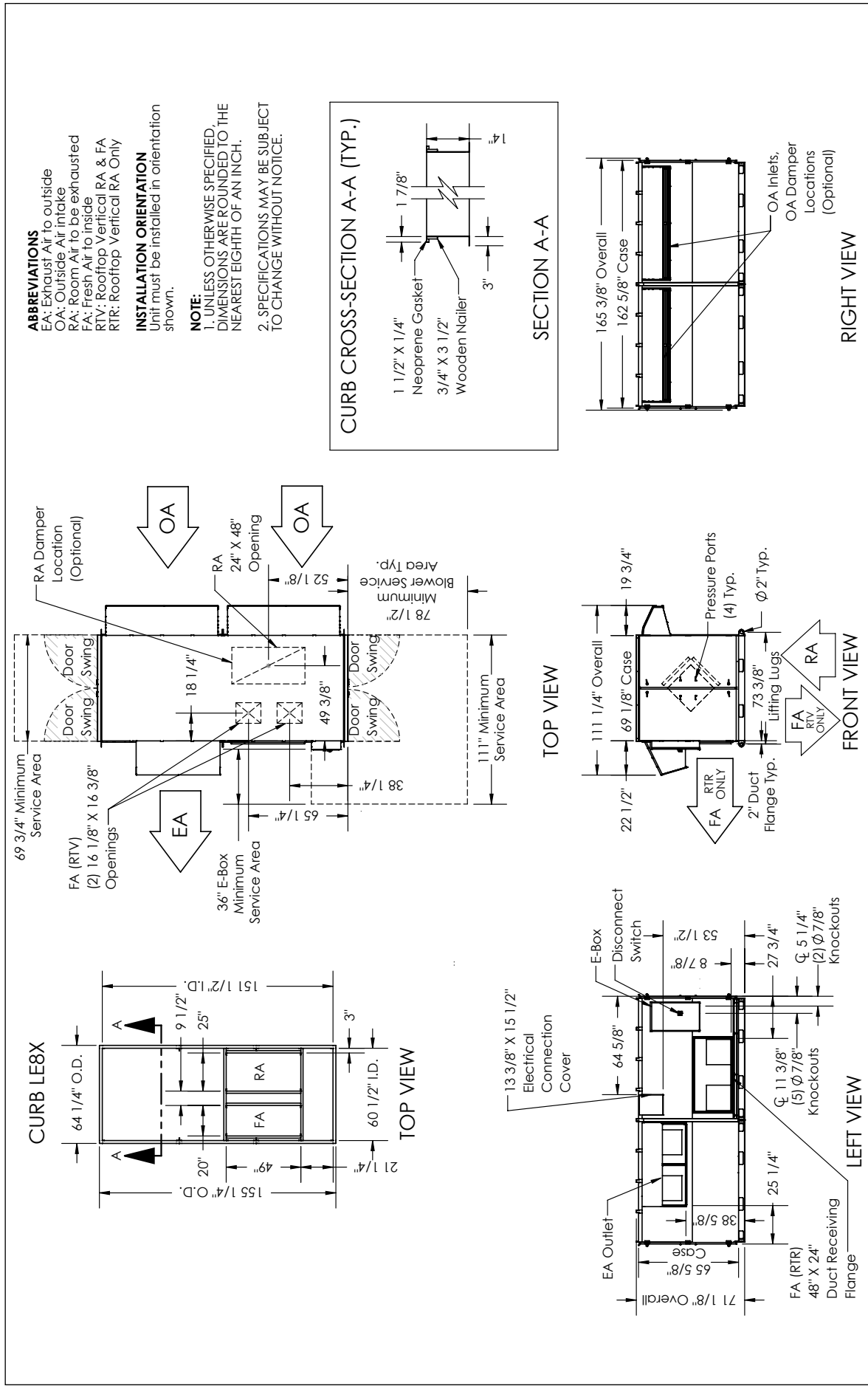

**UNIT MOUNTING & APPLICATION**



Must be mounted as shown. Airstreams cannot be switched.

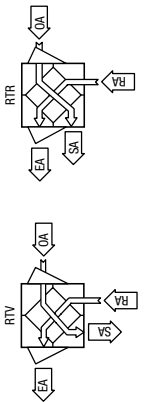

**AIRFLOW ORIENTATION**

Available as shown.



# LE 10XINH

## ENERGY RECOVERY VENTILATOR



### ROOFTOP UNIT



LE10XINH shown

Energy recovery core is AHRI Certified®



### SPECIFICATIONS

**Ventilation Type:** Static plate, heat and humidity transfer

**Typical Airflow Range:** 2,500–11,000 CFM

**AHRI 1060 Certified Core:** Ten L125-G5

**Standard Features:**

- TEFC Premium efficiency motors
- Motor starters
- Non-fused disconnect
- 24VAC transformer/relay package
- Rubber vibration isolators
- Cross-core differential pressure ports
- Independent blower control

**Filters:** Total qty. 20, MERV 8: 20" x 25" x 2"

**Unit Weight:**

- Modular (2-modules) 1,423–1,912 lbs., varies by option(s)
- Assembled (1-piece) 2,858–3,799 lbs., varies by option(s)

**Max. Shipping Dimensions & Weight (on pallet):**

- Modular (2-modules) 120" L x 90" W x 78" H
- Module 1: 2,132 lbs., Module 2: 2,107 lbs.
- Assembled (1-piece) 240" L x 90" W x 78" H; 4,239 lbs.

**Motor(s):**

- Qty. 2, Belt drive blower/standard motor packages
- with choice of adjustable sheaves (see table below)

**Options:**

- Spring vibration isolators
- Ultra premium efficiency (IE5+) motors with variable frequency drives (VFDs): both airstreams
- Onboard VFDs: both airstreams
- Shaft grounding ring on motors with VFDs
- Fused disconnect
- Integrated programmable controls: enhanced, premium
- Class 1 low leakage motorized isolation dampers: FA, EA or both airstreams
- Factory mounted filter alarms: both airstreams
- Double wall construction
- Exterior paint - white, custom colors

**Accessories:**

- Filters: MERV 13, 2" or 4"; MERV 8, 4"; (shipped loose)
- Automatic balancing damper: 4", 5", 6"
- Digital time clock: wall mount (TC7D-W), in exterior enclosure (TC7D-E)
- Carbon dioxide sensor/control wall mount (CO2-W), duct mount (CO2-D)
- IAQ sensor: wall mount (IAQ-W), duct mount (IAQ-D)
- Motion occupancy sensor/control: ceiling mount (MC-C), wall mount (MC-W)
- Smoke Detector: duct mount (SD-D)
- BACnet fan control: wall mount (BACNETFC-W)
- Indoor electric duct heater: EK series (1–175 kW);
- Indirect gas-fired duct furnace: GH series (50–400 MBH); Installed downstream of any fans

### AIRFLOW PERFORMANCE

Airflow CFM	External Static Pressure (in.w.g.)																		
	0.00		0.25		0.50		0.75		1.00		1.25		1.50		1.75		2.00		
	BHP	RPM	BHP	RPM	BHP	RPM	BHP	RPM	BHP	RPM	BHP	RPM	BHP	RPM	BHP	RPM	BHP	RPM	
								3 HP LOW SPEED				3 HP MED SPEED		3 HP HIGH SPEED					
2500								1.1	710	1.3	790	1.6	870	1.8	930	2.1	1000	2.4	1050
3000					1.0	640	1.3	730	1.5	810	1.8	880	2.0	950	2.3	1010	2.6	1070	
3500					1.2	660	1.4	750	1.7	830	2.0	900	2.3	960	2.6	1020	2.9	1080	
4000					1.4	680	1.6	770	1.9	840	2.2	910	2.5	980	2.9	1040	3.2	1100	
4500					1.6	710	1.9	790	2.2	860	2.5	930	2.8	990	3.2	1050	3.5	1110	
5000				1.6	670	1.9	740	2.1	810	2.5	880	2.8	940	3.1	1000	3.5	1060	3.9	1120
5500		1.6	640	1.9	710	2.2	770	2.5	840	2.8	900	3.1	960	3.5	1020	3.8	1080	4.2	1130
6000	3 HP LOW SPEED	2.0	690	2.2	750	2.5	810	2.8	870	3.1	920	3.5	980	3.9	1040	4.2	1090	4.6	1150
6500	3 HP LOW SPEED	2.4	740	2.6	790	2.9	850	3.2	900	3.6	950	3.9	1000	4.3	1060	4.7	1110	5.1	1160
7000	3 HP LOW SPEED	2.8	790	3.1	830	3.4	880	3.7	930	4.0	980	4.4	1030	4.8	1080	5.2	1130	5.6	1170
7500	5 HP LOW SPEED	3.3	830	3.6	880	3.9	920	4.2	970	4.6	1010	4.9	1050	5.3	1100	5.7	1140	6.1	1190
8000	5 HP LOW SPEED	3.9	880	4.2	920	4.5	960	4.8	1000	5.1	1040	5.5	1080	5.9	1120	6.3	1160	6.7	1200
8500	5 HP MED SPEED	4.5	930	4.8	960	5.1	1000	5.4	1030	5.8	1070	6.1	1100	6.5	1140	6.9	1180	7.3	1210
9000		5.2	970	5.5	1000	5.8	1030	6.1	1060	6.4	1100	6.8	1130	7.1	1160	7.5	1190	7.9	1220
9500	7.5 HP LOW SPEED	5.9	1010	6.2	1040	6.5	1060	6.8	1090	7.1	1120	7.5	1150	7.8	1180	8.2	1210	8.5	1230
10000	7.5 HP LOW SPEED	6.7	1040	7.0	1070	7.3	1090	7.6	1120	7.9	1140	8.2	1170	8.5	1190	8.9	1220	9.2	1240
10500	7.5 HP MED SPEED	7.5	1080	7.8	1100	8.1	1120	8.4	1140	8.7	1160	9.0	1190	9.3	1210	9.6	1230	10.0	1250
11000		8.4	1100	8.6	1120	8.9	1140	9.2	1160	9.5	1180	9.8	1200						
		10 HP MED SPEED								10 HP HIGH SPEED									

Note: Airflow performance includes effect of clean, standard filter supplied with unit.





ENERGY RECOVERY VENTILATOR



ELECTRICAL DATA

Electrical Specifications				Motor Starters (Standard)			Optional IE3 Efficiency Motor with VFDs			Optional IE5+ Efficiency Motor with VFDs		
HP	Volts	HZ	Phase	FLA per Motor	Min. Cir. Amps	Max. Overcurrent Protection Device	FLA per Motor	Min. Cir. Amps	Max. Overcurrent Protection Device	FLA per Motor	Min. Cir. Amps	Max. Overcurrent Protection Device
3.0	208-230	60	Single	14.6-14.0	32.9	45.0	9.0-8.4	35.1	50.0	7.3-7.3	28.4	40.0
3.0	208-230	60	Three	9.0-8.4	20.3	25.0	9.0-8.4	20.3	25.0	7.3-7.3	16.4	20.0
	460	60	Three	4.2	9.5	15.0	4.2	9.5	15.0	3.7	8.3	15.0
	575	60	Three	3.3	7.4	15.0	3.3	7.4	15.0			
5.0	208-230	60	Three	13.9-13.4	31.3	45.0	13.9-13.4	31.3	45.0	10.5-10.5	23.6	30.0
	460	60	Three	6.7	15.1	20.0	6.7	15.1	20.0	5.3	11.9	15.0
	575	60	Three	5.3	11.9	15.0	5.3	11.9	15.0			
7.5	208-230	60	Three	20.0-19.0	45.0	60.0	20.0-19.0	45.0	60.0	17.4-17.4	39.2	50.0
	460	60	Three	9.5	21.4	30.0	9.5	21.4	30.0	8.7	19.6	25.0
	575	60	Three	7.6	17.1	20.0	7.6	17.1	20.0			
10.0	208-230	60	Three	25.4-24	57.2	80	25.4-24	57.2	80	22.0-22.0	49.5	70
	460	60	Three	12	27.0	35	12	27.0	35	11	24.8	35
	575	60	Three	9.6	21.6	30	9.6	21.6	30			

**LE10XINH ENERGY RECOVERY VENTILATOR**

**ABBREVIATIONS**

- EA: Exhaust Air to outside
- OA: Outside Air intake
- RA: Room Air to be exhausted
- FA: Fresh Air to inside

**INSTALLATION ORIENTATION**

Unit must be installed in orientation shown.

**NOTE**

1. UNLESS OTHERWISE SPECIFIED, DIMENSIONS ARE ROUNDED TO THE NEAREST EIGHTH OF AN INCH.
2. SPECIFICATIONS MAY BE SUBJECT TO CHANGE WITHOUT NOTICE.
3. MIN. DUCT CLEARANCE FROM DAMPER BLADES WHEN FULLY OPENED TO BE 2". SMA/CNA RULES APPLY.

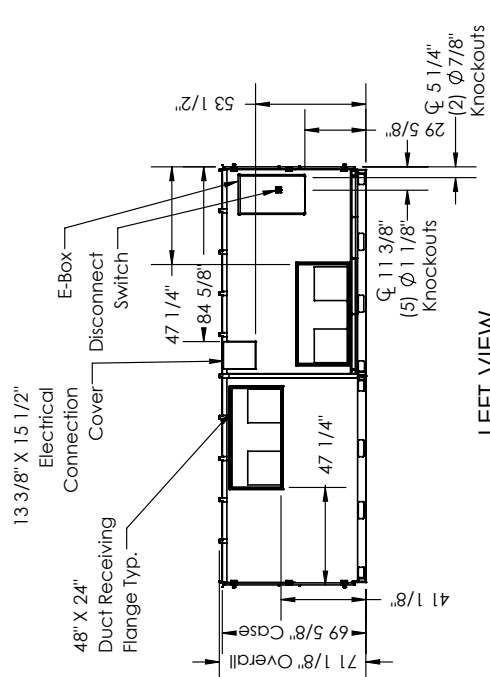
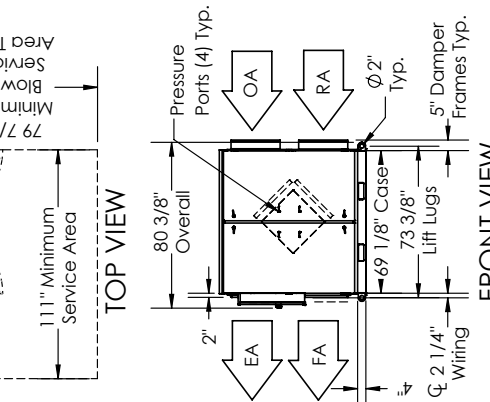
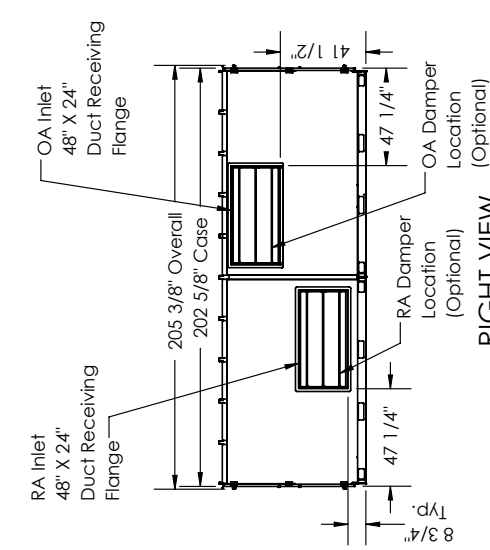
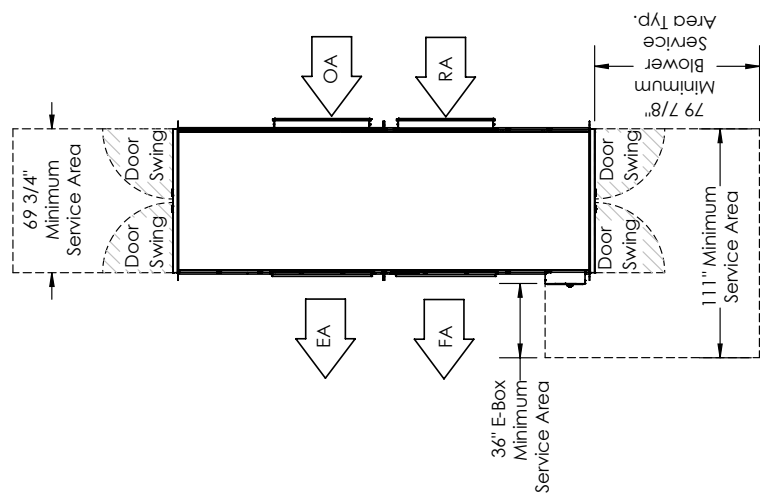

**UNIT MOUNTING & APPLICATION**  
 Must be mounted as shown. RA/EA airstream can be switched with OA/FA airstream unless certain options are selected.



**AIRFLOW ORIENTATION**  
 Available as shown.





ENERGY RECOVERY VENTILATOR



ROOFTOP UNIT



SPECIFICATIONS

**Ventilation Type:** Static plate, heat and humidity transfer

**Typical Airflow Range:** 2,500–11,000 CFM

**AHRI 1060 Certified Core:** Ten L125-G5

**Standard Features:**

- TEFC Premium efficiency motors
- Motor starters
- Non-fused disconnect
- 24VAC transformer/relay package
- Rubber vibration isolators
- Cross-core differential pressure ports
- Independent blower control

**Filters:** Total qty. 20, MERV 8: 20" x 25" x 2"

**Unit Weight:**

- Modular (2-modules) 1,127–2,222 lbs., varies by option(s)
- Assembled (1-piece) 2,858–3,788 lbs., varies by option(s)

**Max. Shipping Dimensions & Weight (on pallet):**

- Modular (2-modules) 120" L x 90" W x 78" H
- Module 1: 2,442 lbs., Module 2: 1,792 lbs.
- Assembled (1-piece) 240" L x 90" W x 78" H; 4,228 lbs.

**Motor(s):**

- Qty. 2, Belt drive blower/standard motor packages
- with choice of adjustable sheaves (see table below)

**Options:**

- Spring vibration isolators
- Ultra premium efficiency (IE5+) motors with variable frequency drives (VFDs): both airstreams
- Onboard VFDs: both airstreams
- Shaft grounding ring on motors with VFDs
- Fused disconnect
- Integrated programmable controls: enhanced, premium
- Class 1 low leakage motorized isolation dampers: FA, EA or both airstreams
- Factory mounted filter alarms: both airstreams
- Double wall construction
- Exterior paint - white, custom colors

**Accessories:**

- Filters: MERV 13, 2" or 4"; MERV 8, 4"; (shipped loose)
- Automatic balancing damper: 4", 5", 6"
- Digital time clock: wall mount (TC7D-W), in exterior enclosure (TC7D-E)
- Carbon dioxide sensor/control wall mount (CO2-W), duct mount (CO2-D)
- IAQ sensor: wall mount (IAQ-W), duct mount (IAQ-D)
- Motion occupancy sensor/control: ceiling mount (MC-C), wall mount (MC-W)
- Smoke Detector: duct mount (SD-D)
- BACnet fan control: wall mount (BACNETFC-W)
- Indoor electric duct heater: EK series (1–175 kW);
- Indirect gas-fired duct furnace: GH series (50–400 MBH);
- Installed downstream of any fans

Energy recovery core is AHRI Certified®



AIRFLOW PERFORMANCE

Airflow CFM	External Static Pressure (in.w.g.)																				
	0.00		0.25		0.50		0.75		1.00		1.25		1.50		1.75		2.00				
	BHP	RPM	BHP	RPM	BHP	RPM	BHP	RPM	BHP	RPM	BHP	RPM	BHP	RPM	BHP	RPM	BHP	RPM			
								3 HP LOW SPEED				3 HP MED SPEED		3 HP HIGH SPEED							
2500								1.1	710	1.3	790	1.6	870	1.8	930	2.1	1000	2.4	1050		
3000					1.0	640	1.3	730	1.5	810	1.8	880	2.0	950	2.3	1010	2.6	1070			
3500					1.2	660	1.4	750	1.7	830	2.0	900	2.3	960	2.6	1020	2.9	1080			
4000					1.4	680	1.6	770	1.9	840	2.2	910	2.5	980	2.9	1040	3.2	1100			
4500					1.6	710	1.9	790	2.2	860	2.5	930	2.8	990	3.2	1050	3.5	1110			
5000				1.6	670	1.9	740	2.1	810	2.5	880	2.8	940	3.1	1000	3.5	1060	3.9	1120		
5500		1.6	640	1.9	710	2.2	770	2.5	840	2.8	900	3.1	960	3.5	1020	3.8	1080	4.2	1130		
6000	3 HP LOW SPEED	2.0	690	2.2	750	2.5	810	2.8	870	3.1	920	3.5	980	3.9	1040	4.2	1090	4.6	1150		
6500	3 HP LOW SPEED	2.4	740	2.6	790	2.9	850	3.2	900	3.6	950	3.9	1000	4.3	1060	4.7	1110	5.1	1160		
7000	3 HP LOW SPEED	2.8	790	3.1	830	3.4	880	3.7	930	4.0	980	4.4	1030	4.8	1080	5.2	1130	5.6	1170		
7500	5 HP LOW SPEED	3.3	830	3.6	880	3.9	920	4.2	970	4.6	1010	4.9	1050	5.3	1100	5.7	1140	6.1	1190		
8000	5 HP LOW SPEED	3.9	880	4.2	920	4.5	960	4.8	1000	5.1	1040	5.5	1080	5.9	1120	6.3	1160	6.7	1200		
8500	5 HP MED SPEED	4.5	930	4.8	960	5.1	1000	5.4	1030	5.8	1070	6.1	1100	6.5	1140	6.9	1180	7.3	1210		
9000		5.2	970	5.5	1000	5.8	1030	6.1	1060	6.4	1100	6.8	1130	7.1	1160	7.5	1190	7.9	1220		
9500	7.5 HP LOW SPEED	5.9	1010	6.2	1040	6.5	1060	6.8	1090	7.1	1120	7.5	1150	7.8	1180	8.2	1210	8.5	1230		
10000	7.5 HP LOW SPEED	6.7	1040	7.0	1070	7.3	1090	7.6	1120	7.9	1140	8.2	1170	8.5	1190	8.9	1220	9.2	1240		
10500	7.5 HP MED SPEED	7.5	1080	7.8	1100	8.1	1120	8.4	1140	8.7	1160	9.0	1190	9.3	1210	9.6	1230	10.0	1250		
11000		8.4	1100	8.6	1120	8.9	1140	9.2	1160	9.5	1180	9.8	1200								
		10 HP MED SPEED							10 HP HIGH SPEED												

Note: Airflow performance includes effect of clean, standard filter supplied with unit.





ENERGY RECOVERY VENTILATOR



ELECTRICAL DATA

Electrical Specifications				Motor Starters (Standard)			Optional IE3 Efficiency Motor with VFDs			Optional IE5+ Efficiency Motor with VFDs		
HP	Volts	HZ	Phase	FLA per Motor	Min. Cir. Amps	Max. Overcurrent Protection Device	FLA per Motor	Min. Cir. Amps	Max. Overcurrent Protection Device	FLA per Motor	Min. Cir. Amps	Max. Overcurrent Protection Device
3.0	208-230	60	Single	14.6-14.0	32.9	45.0	9.0-8.4	35.1	50.0	7.3-7.3	28.4	40.0
3.0	208-230	60	Three	9.0-8.4	20.3	25.0	9.0-8.4	20.3	25.0	7.3-7.3	16.4	20.0
	460	60	Three	4.2	9.5	15.0	4.2	9.5	15.0	3.7	8.3	15.0
	575	60	Three	3.3	7.4	15.0	3.3	7.4	15.0			
5.0	208-230	60	Three	13.9-13.4	31.3	45.0	13.9-13.4	31.3	45.0	10.5-10.5	23.6	30.0
	460	60	Three	6.7	15.1	20.0	6.7	15.1	20.0	5.3	11.9	15.0
	575	60	Three	5.3	11.9	15.0	5.3	11.9	15.0			
7.5	208-230	60	Three	20.0-19.0	45.0	60.0	20.0-19.0	45.0	60.0	17.4-17.4	39.2	50.0
	460	60	Three	9.5	21.4	30.0	9.5	21.4	30.0	8.7	19.6	25.0
	575	60	Three	7.6	17.1	20.0	7.6	17.1	20.0			
10.0	208-230	60	Three	25.4-24	57.2	80	25.4-24	57.2	80	22.0-22.0	49.5	70
	460	60	Three	12	27.0	35	12	27.0	35	11	24.8	35
	575	60	Three	9.6	21.6	30	9.6	21.6	30			

**LE10XIN V ENERGY RECOVERY VENTILATOR**

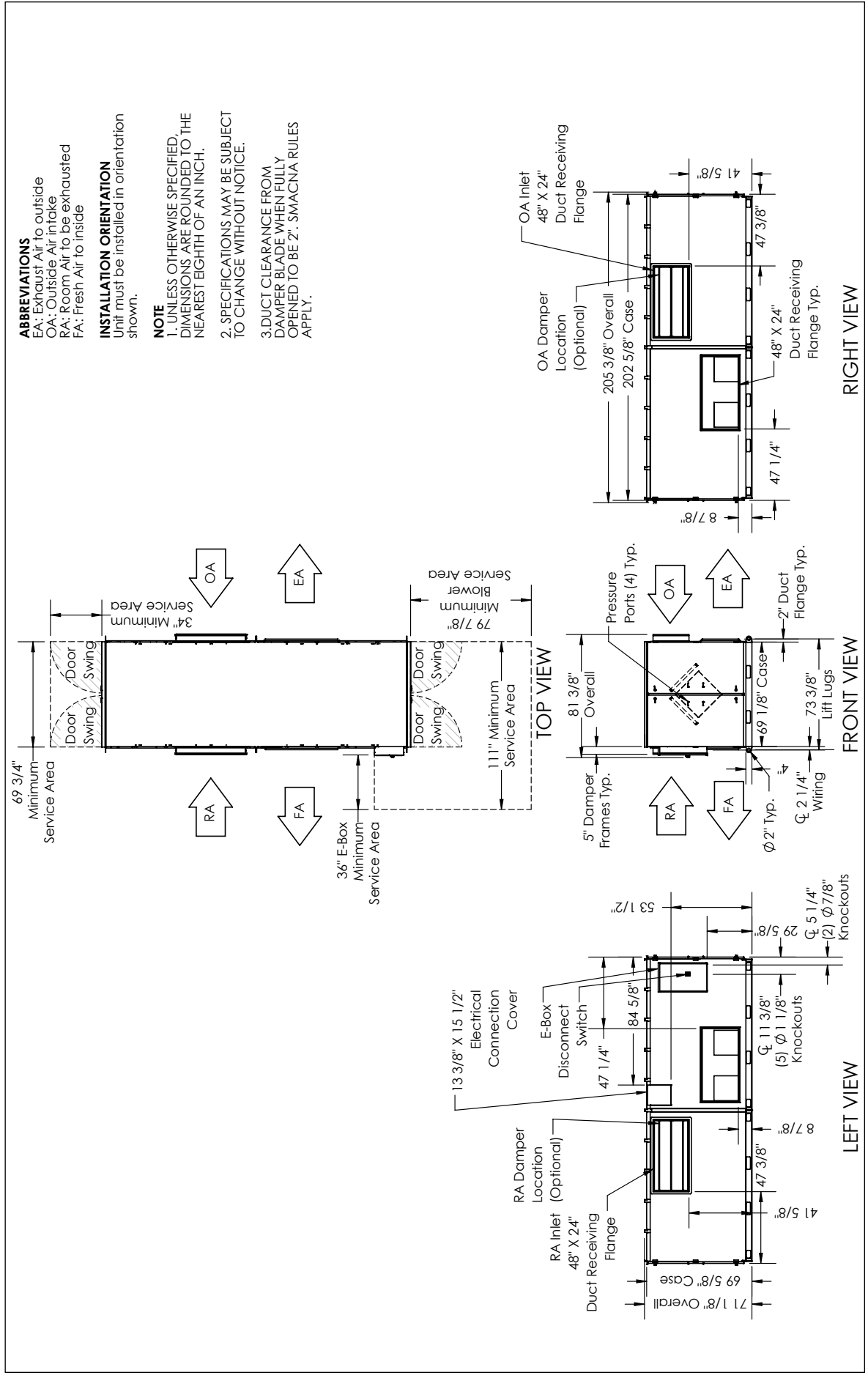

**AIRFLOW ORIENTATION**  
 Available as shown.

**UNIT MOUNTING & APPLICATION**  
 Must be mounted as shown. RA/EA airstream can be switched with OA/FA airstream unless certain options are selected.



ENERGY RECOVERY VENTILATOR



ROOFTOP UNIT



SPECIFICATIONS

**Ventilation Type:** Static plate, heat and humidity transfer

**Typical Airflow Range:** 2,000–8,800 CFM

**AHRI 1060 Certified Core:** Six L125-G5

**Standard Features:**

- TEFC Premium efficiency motors
- Motor starters
- Non-fused disconnect
- 24VAC transformer/relay package
- Cross-core differential pressure ports
- Independent blower control

**Filters:** Total qty. 12, MERV 8: 20" x 25" x 2"

**Unit Weight:**

- Modular (per module) 1,311–1,806 lbs., varies by option(s)
- Assembled (1-piece) 2,631–3,453 lbs., varies by option(s)

**Max. Shipping Dimensions & Weight (on pallet):**

- Modular (2-modules) 80" L x 90" W x 78" H
- Module 1: 1,986 lbs., Module 2: 1,917 lbs.
- Assembled (1-piece) 200" L x 90" W x 78" H; 3,812 lbs.

**Motor(s):**

- Qty. 2, Belt drive blower/standard motor packages
- with choice of adjustable sheaves (see table below)

**Options:**

- Spring vibration isolators
- Ultra premium efficiency (IE5+) motors with variable frequency drives (VFDs): both airstreams
- Onboard VFDs: both airstreams
- Shaft grounding ring on motors with VFDs
- Fused disconnect
- Integrated programmable controls: enhanced, premium
- Class 1 low leakage motorized isolation dampers: FA, EA or both airstreams
- Factory mounted filter alarms: both airstreams
- Double wall construction
- Exterior paint - white, custom colors

**Accessories:**

- Filters: MERV 13, 2" (shipped loose)
- Automatic balancing damper: 4", 5", 6"
- Roof curb: standard 14"
- Curb wind clip
- Engineered combo curb for Carrier RTU
- Engineered combo curb for Trane RTU
- Digital time clock: wall mount (TC7D-W), in exterior enclosure (TC7D-E)
- Carbon dioxide sensor/control: wall mount (CO2-W), duct mount (CO2-D)
- IAQ sensor: wall mount (IAQ-W), duct mount (IAQ-D)
- Motion occupancy sensor/control: ceiling mount (MC-C), wall mount (MC-W)
- Smoke Detector: duct mount (SD-D)
- BACnet fan control: wall mount (BACNETFC-W)
- Indoor electric duct heater: EK series (1–175 kW);
- Indirect gas-fired duct furnace: GH series (50–400 MBH); installed downstream of any fans

Energy recovery core is AHRI Certified®



AIRFLOW PERFORMANCE

Airflow CFM	External Static Pressure (in.w.g.)																			
	0.00		0.25		0.50		0.75		1.00		1.25		1.50		1.75		2.00			
	BHP	RPM	BHP	RPM	BHP	RPM	BHP	RPM	BHP	RPM	BHP	RPM	BHP	RPM	BHP	RPM	BHP	RPM		
							3 HP LOW SPEED				3 HP MED SPEED		3 HP HIGH SPEED							
2500							1.1	710	1.3	790	1.6	870	1.8	930	2.1	1000	2.4	1050		
3000							1.0	640	1.3	730	1.5	810	1.8	880	2.0	950	2.3	1010	2.6	1070
3500							1.2	660	1.4	750	1.7	830	2.0	900	2.3	960	2.6	1020	2.9	1080
4000							1.4	680	1.6	770	1.9	840	2.2	910	2.5	980	2.9	1040	3.2	1100
4500							1.6	710	1.9	790	2.2	860	2.5	930	2.8	990	3.2	1050	3.5	1110
5000							1.6	670	1.9	740	2.1	810	2.5	880	2.8	940	3.1	1000	3.5	1120
5500	3 HP LOW SPEED	1.6	640	1.9	710	2.2	770	2.5	840	2.8	900	3.1	960	3.5	1020	3.8	1080	4.2	1130	
6000		2.0	690	2.2	750	2.5	810	2.8	870	3.1	920	3.5	980	3.9	1040	4.2	1090	4.6	1150	
6500	5 HP LOW SPEED	2.4	740	2.6	790	2.9	850	3.2	900	3.6	950	3.9	1000	4.3	1060	4.7	1110	5.1	1160	
7000		2.8	790	3.1	830	3.4	880	3.7	930	4.0	980	4.4	1030	4.8	1080	5.2	1130	5.6	1170	
7500	5 HP MED SPEED	3.3	830	3.6	880	3.9	920	4.2	970	4.6	1010	4.9	1050	5.3	1100	5.7	1140	6.1	1190	
8000		3.9	880	4.2	920	4.5	960	4.8	1000	5.1	1040	5.5	1080	5.9	1120	6.3	1160	6.7	1200	
8500	7.5 HP LOW SPEED	4.5	930	4.8	960	5.1	1000	5.4	1030	5.8	1070	6.1	1100	6.5	1140	6.9	1180	7.3	1210	
9000		5.2	970	5.5	1000	5.8	1030	6.1	1060	6.4	1100	6.8	1130	7.1	1160	7.5	1190	7.9	1220	
9500	7.5 HP MED SPEED	5.9	1010	6.2	1040	6.5	1060	6.8	1090	7.1	1120	7.5	1150	7.8	1180	8.2	1210	8.5	1230	
10000		6.7	1040	7.0	1070	7.3	1090	7.6	1120	7.9	1140	8.2	1170	8.5	1190	8.9	1220	9.2	1240	
10500	10 HP HIGH SPEED	7.5	1080	7.8	1100	8.1	1120	8.4	1140	8.7	1160	9.0	1190	9.3	1210	9.6	1230	10.0	1250	
11000		8.4	1100	8.6	1120	8.9	1140	9.2	1160	9.5	1180	9.8	1200							
	10 HP MED SPEED									10 HP HIGH SPEED										

Note: Airflow performance includes effect of clean, standard filter supplied with unit.







ENERGY RECOVERY VENTILATOR



ELECTRICAL DATA

Electrical Specifications				Motor Starters (Standard)			Optional IE3 Efficiency Motor with VFDs			Optional IE5+ Efficiency Motor with VFDs		
HP	Volts	HZ	Phase	FLA per Motor	Min. Cir. Amps	Max. Overcurrent Protection Device	FLA per Motor	Min. Cir. Amps	Max. Overcurrent Protection Device	FLA per Motor	Min. Cir. Amps	Max. Overcurrent Protection Device
3.0	208-230	60	Single	14.6-14.0	32.9	45.0	9.0-8.4	35.1	50.0	7.3-7.3	28.4	40.0
3.0	208-230	60	Three	9.0-8.4	20.3	25.0	9.0-8.4	20.3	25.0	7.3-7.3	16.4	20.0
	460	60	Three	4.2	9.5	15.0	4.2	9.5	15.0	3.7	8.3	15.0
	575	60	Three	3.3	7.4	15.0	3.3	7.4	15.0			
5.0	208-230	60	Three	13.9-13.4	31.3	45.0	13.9-13.4	31.3	45.0	10.5-10.5	23.6	30.0
	460	60	Three	6.7	15.1	20.0	6.7	15.1	20.0	5.3	11.9	15.0
	575	60	Three	5.3	11.9	15.0	5.3	11.9	15.0			
7.5	208-230	60	Three	20.0-19.0	45.0	60.0	20.0-19.0	45.0	60.0	17.4-17.4	39.2	50.0
	460	60	Three	9.5	21.4	30.0	9.5	21.4	30.0	8.7	19.6	25.0
	575	60	Three	7.6	17.1	20.0	7.6	17.1	20.0			
10.0	208-230	60	Three	25.4-24	57.2	80	25.4-24	57.2	80	22.0-22.0	49.5	70
	460	60	Three	12	27.0	35	12	27.0	35	11	24.8	35
	575	60	Three	9.6	21.6	30	9.6	21.6	30			

**LE10XRT (RTV/RTR) ENERGY RECOVERY VENTILATOR**

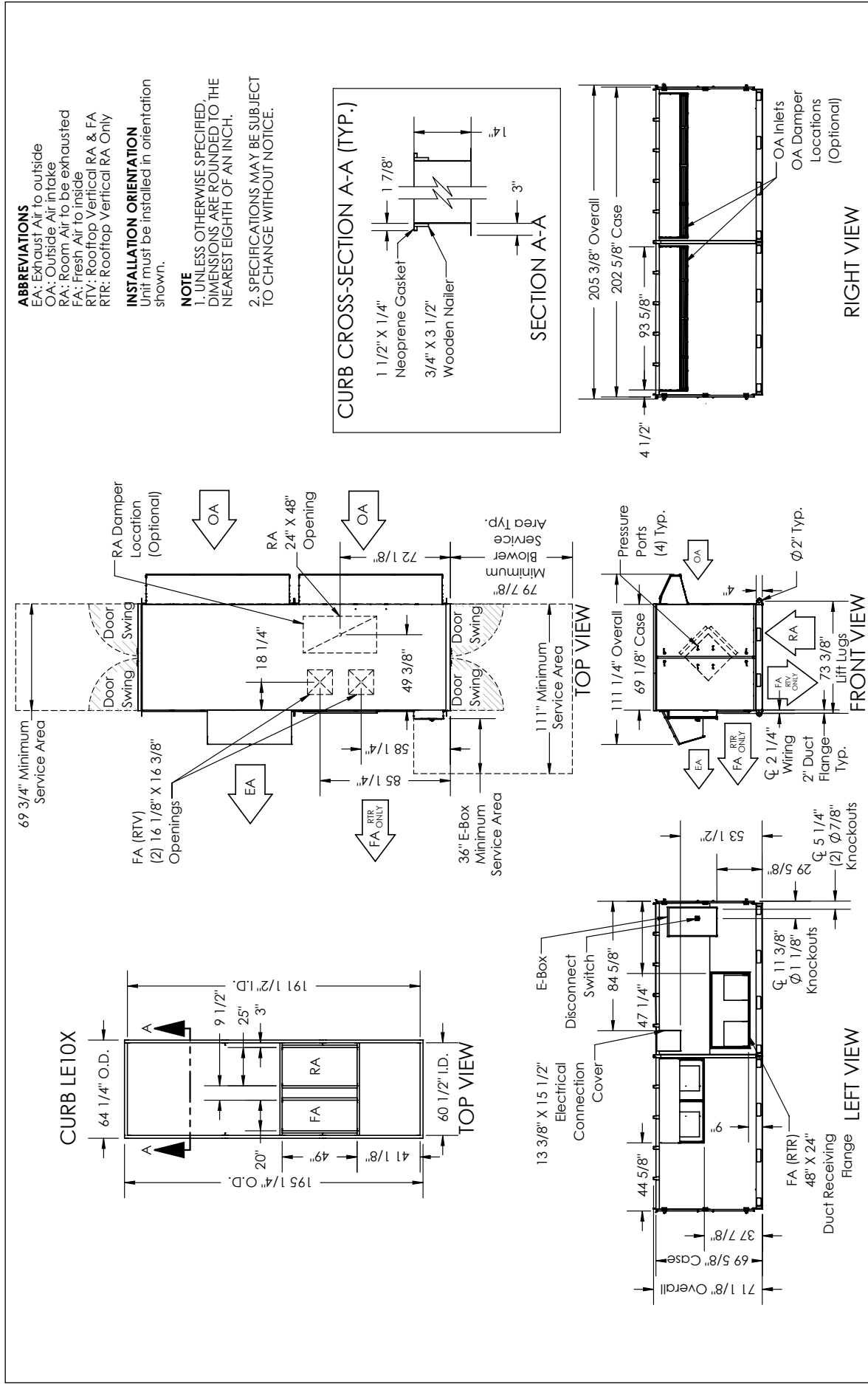

**UNIT MOUNTING & APPLICATION**



Must be mounted as shown. Airstreams cannot be switched.

**AIRFLOW ORIENTATION**

Available as shown in dimension drawing.

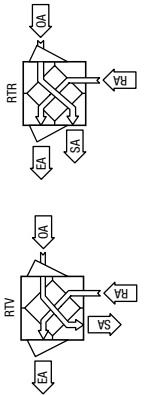

**LE10XRT (RTH/RTF) ENERGY RECOVERY VENTILATOR**

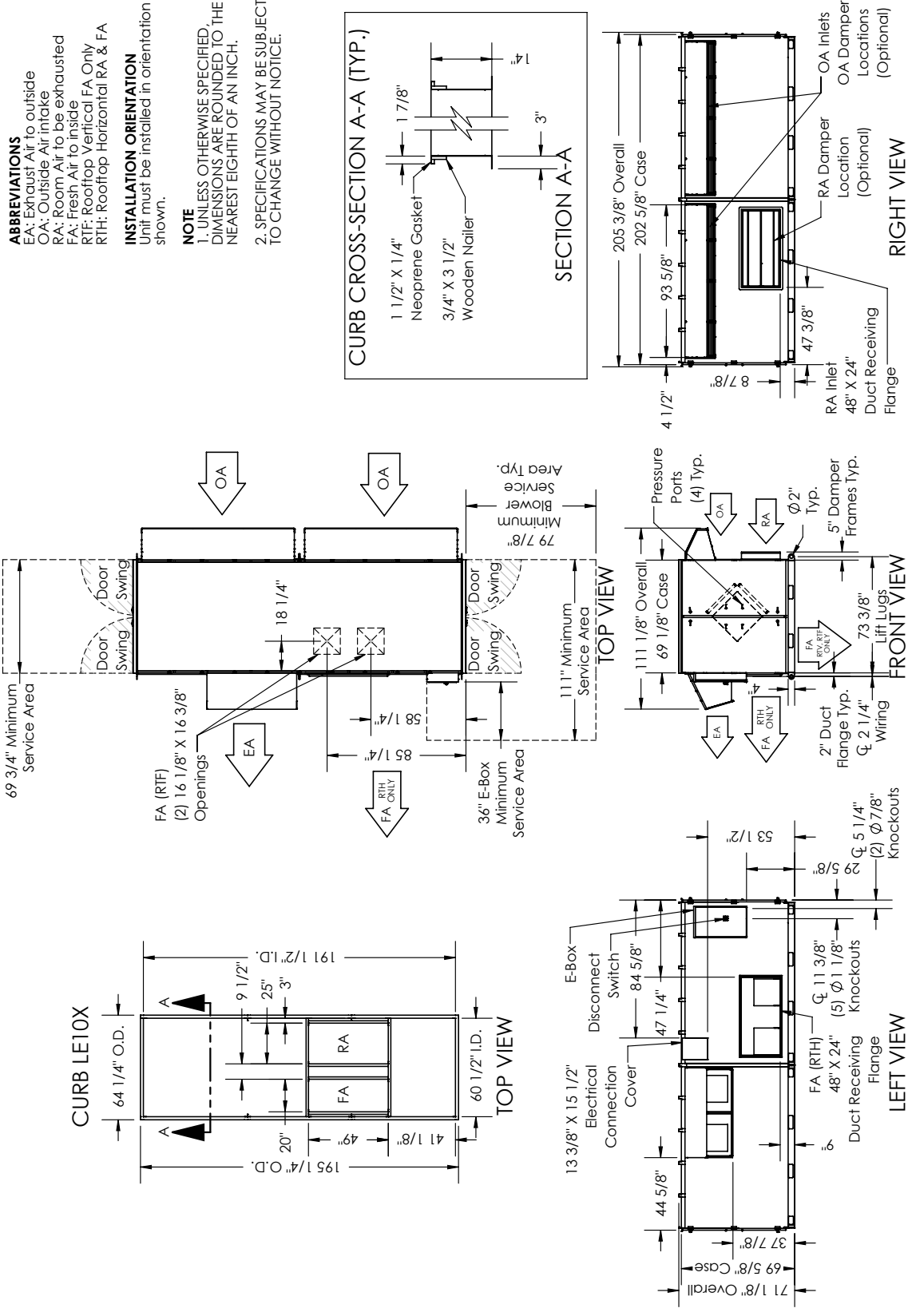

**UNIT MOUNTING & APPLICATION**  
 Must be mounted as shown. Airstreams cannot be switched.



**AIRFLOW ORIENTATION**  
 Available as shown in dimension drawing.



# APPLICATIONS

## COMMON INSTALLATION APPROACHES

### AIR SUPPLIED TO INTAKES OF TERMINAL UNITS

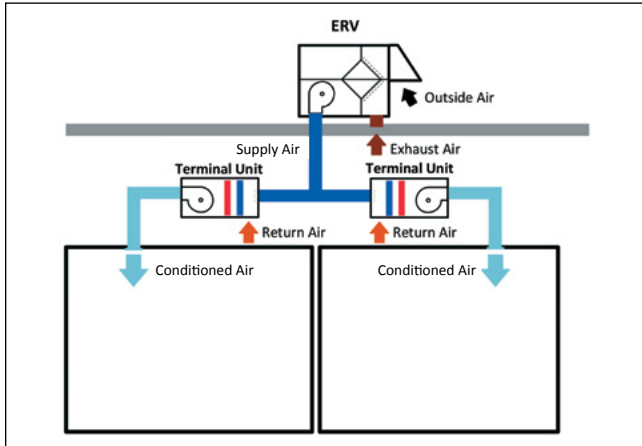

- Variable refrigerant flow/volume
- Fan coils
- Active chilled beam

### DIRECT-TO-ZONE WITH TERMINAL UNITS

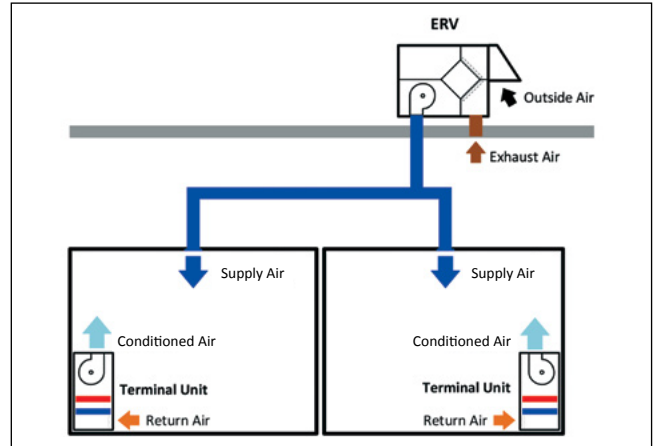

- Variable refrigerant flow/volume
- Fan coils
- Heat pumps
- Chilled beam
- Radiant floor heating & cooling
- Packaged terminal air conditioning

### SUPPLY AIR TO MIXING BOXES FOR INDOOR TERMINAL UNITS OR ROOFTOPS

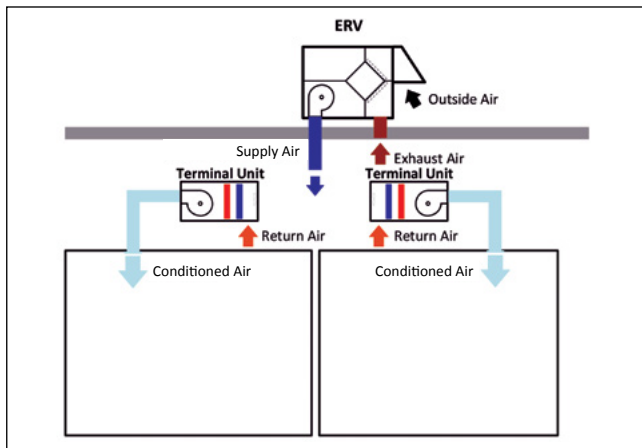

- Variable refrigerant flow/volume
- Fan coils
- Chilled beam

### DIRECT-TO-ZONE WITH ROOFTOP OR ALTERNATIVELY TO MIXING BOX OF ROOFTOP UNITS (SEE DOTTED LINE)

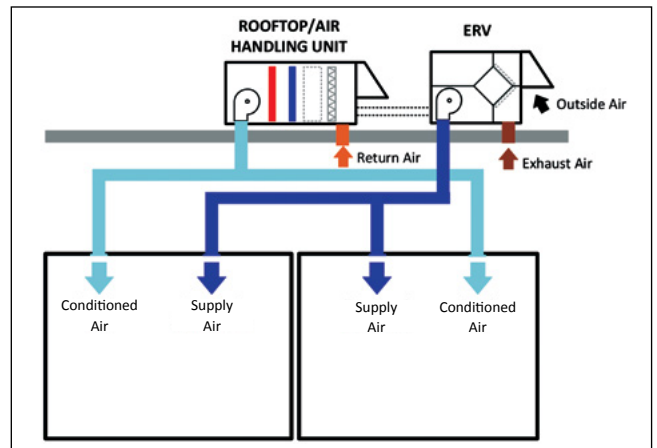

**Note:** Rooftop applications shown, configuration can be applied to indoor units

# OPTIONS

See individual submittal pages for availability by model.

## ULTRA PREMIUM EFFICIENCY (IE5+) MOTOR WITH VARIABLE FREQUENCY DRIVE (VFD)

- ♦ Highly efficient at full load and partial load conditions
- ♦ Greater energy efficiency than standard IE3 motors
- ♦ Internal grounding bushings
- ♦ Synchronous reluctance and permanent sustainable non-rare earth magnetic technologies
- ♦ VFDs required
- ♦ See VFD option for additional features



## VARIABLE FREQUENCY DRIVE

- ♦ Factory supplied and mounted variable frequency drives (VFDs): one or both airstreams
- ♦ Provides additional control options
- ♦ Separate VFD for each airstream
- ♦ Display/control in electrical box: can be remotely mounted
- ♦ Pre-programmed speeds or variable speed
- ♦ Easy airflow setup using RenewAire's standard pressure ports: cuts commissioning time
- ♦ Shaft grounding ring on motors with VFDs



## FILTER ALARM

- ♦ Factory mounted airflow switches: one for each airstream
- ♦ Allows for remote indication of loaded (dirty) filter



## ELECTRICAL

- ♦ Disconnect fuses and motor starters
- ♦ Independent blower control (IBC) available as an option for HE1.5X



## MOTORIZED ISOLATION DAMPERS

- ♦ Class 1, low leakage
- ♦ Robust, reliable actuators for highest dependability
- ♦ Automatic operation with spring return in event of power loss
- ♦ Damper(s) are factory mounted and wired



## EXTERIOR PAINT

- ♦ White and custom colors available



# OPTIONS

## INTEGRATED PROGRAMMABLE CONTROLS

RenewAire's Integrated Programmable Controls optimize the usability and performance of our commercial ERVs by improving functionality, enabling intelligent controls, streamlining operations and boosting efficiencies. This is accomplished via sophisticated factory-installed microprocessor controls and sensors that provide stand-alone ERVs with Direct Digital Control (DDC) and/or Building Management System (BMS) control interface.



### KEY BENEFITS

**Optimize usability:**

- ♦ Maximize ERV functionality and intelligent control via remote Ethernet accessibility and BMS connectivity without third-party interface.
- ♦ Streamline operations by easily managing and changing ERV control parameters via an advanced user interface.
- ♦ Increase uptime reliability through constant system monitoring.
- ♦ Achieve cleaner and healthier indoor air via IAQ-based ERV control.

**Improve performance:**

- ♦ Support effective and efficient ERV performance with real-time data trending and logging capabilities.
- ♦ Enhance ERV control via access to real-time airflow rates, airstream temperature and airstream humidity.
- ♦ Facilitate fast and easy ERV upkeep and maintenance with real-time fan, filter and bypass status.

**Increase capabilities:**

- ♦ Expand ERV connectivity via access to a wide range of open standard protocols, including BACnet and Modbus.
- ♦ Broaden ERV interoperability by connecting to third-party equipment and receiving third-party signals for unit control.
- ♦ Expand ERV-application scope by meeting new code requirements and the needs of institutional customers requiring DDC controls in mechanical equipment.

**Simplify operations:**

- ♦ Achieve easier ERV setup, commissioning and balancing via simple-to-install controls.
- ♦ Improve operational efficiencies by easily communicating ERV status, airflows, temperatures and humidity.
- ♦ Allow for more installations by enabling ERVs to be interconnected with a BMS, operated independently or run in concert with other ERVs.

### ACCESSORIES (AVAILABLE WITH INTEGRATED PROGRAMMABLE CONTROLS)

	Enhanced Controls	Premium Controls
CO2 sensor (wall or duct mount)		♦
IAQ sensor (wall or duct mount)		♦
Room pressure sensor (with or without display)		♦
Duct static pressure sensor (with or without display)		♦
Conditioned air temperature sensor		♦
Occupancy sensor (ceiling or wall mount)	♦	♦
Smoke detector (duct mount)	♦	♦
BACnet factory activation (MS/TP or TCP/IP)	♦	♦
Remote display (handheld or wall mount)	♦	♦

# OPTIONS

## CONTROLS

### MODELS

#### Standard Controls via dry contact and relays

Our ERV units are provided with a dry contact that can be used to control the unit with a variety of low-voltage (24VAC) control devices such as remote switches or relays. In addition, third-party analog output can be used to operate the ERV.

#### Enhanced Controls Carel [c.pCOMini] with or without BACnet

Enhanced controls offer automated control, including temperature and humidity control with data trending via microprocessor controls and sensors that enable BMS connectivity.

#### Premium Controls Carel [c.pCOMini] with expansion module with or without BACnet

Premium controls include all functionality of Enhanced-controls capabilities, as well as airflow and IAQ monitoring, demand control, electric or gas heating options, as well as RD-Series cooling and heating control.

**Note:** It is not necessary that RenewAire controls be used to operate RenewAire units. A wide range of controls or building automation systems may be used.

### FEATURE COMPARISON

	Standard Controls	Enhanced Controls	Premium Controls
Ability to automatically enable and disable unit	♦	♦	♦
Filter alarm for both sets of filters	Option <sup>1</sup>	♦	♦
Bypass controls	Option on HE Series (IN) <sup>2</sup>	Option on HE Series (IN) <sup>2</sup>	Option on HE Series (IN) <sup>2</sup>
Control isolation dampers	Option <sup>2</sup>	♦	♦
Supply fan only modulation for VFD/ECM units	Option <sup>3</sup>	♦	♦
Exhaust fan only modulation for VFD/ECM units	Option <sup>3</sup>	♦	♦
Internal time clock	Accessory <sup>4</sup>	♦	♦
Frost controls—Canada only	Option <sup>5</sup>	♦	♦
Smoke detector input required	Accessory <sup>4</sup>	♦	♦
Demand control ventilation using CO <sub>2</sub> —sensor required	Accessory <sup>6</sup>		♦
IAQ control ventilation using VOC—sensor required	Accessory <sup>6</sup>		♦
Occupancy-based ventilation—sensor required	Accessory <sup>6</sup>	♦	♦
Microprocessor controller		♦	♦
Provide supply and exhaust air temperatures		♦	♦
Provide outside and return air temperature and humidity		♦	♦
Fan status on both fans		♦	♦
Enable the supply fan only	Option <sup>5</sup>	♦	♦
Enable the exhaust fan only	Option <sup>5</sup>	♦	♦
Micro USB port		♦	♦
BACnet MS/TP or BACnet TCP/IP—activation required		♦	♦
Modbus		♦	♦
Data trending		♦	♦
Outside airflow rate			♦
Exhaust airflow rate			♦
Space pressure control—sensor required			♦
Duct pressure control—sensor required			♦
Conditioned air temperature—sensor required			♦
Heating enable			♦
Cooling enable			♦
Heating modulation—staged or modulating			♦
Cooling modulation—staged or modulating			♦

**Notes:**

1. Wiring and any indications provided by others.
2. Availability varies per model.
3. VFD and EC models only.
4. Field installed.
5. Non-EC models only. Requires independent blower control.
6. Field installed, on/off control only.



# ACCESSORIES

## CONTROLS

Standard controls are intended to turn RenewAire commercial energy recovery ventilation systems on and off at appropriate times. Specification, installation and set-up is an easy process. RenewAire HE Series units come standard with a 24 Volt transformer/relay package for easy interface with all controls.

**\*Compatible with Standard or Integrated Programmable Controls.**

**\*\*Only Compatible with Integrated Programmable Controls.**

**\*\*\*Only Compatible with Standard Controls.**

### DIGITAL TIME CLOCK\*

- Up to 8 on/off cycles per day or 56 per week
- 24VAC power requirement
- Battery back-up
- Wall mount or outdoor enclosure options
- Wall mount fits any 4" x 4" electrical box



TC7D-W  
Wall Mount

### IAQ SENSORS\*

- Measures TVOC
- Adjustable range from 0–2000 ppm
- Digital display on wall mount
- 24VAC power required
- Internal menu for easy set-up
- Digital control output for use with standard controls



IAQ-W  
Wall Mount

### SMOKE DETECTOR\*

- Photoelectric type detector
- Plug-in sensor
- Round, square or rectangular duct mounting options
- Easy access test/reset button and LED display
- For 100–4000 fpm duct air velocity applications
- 24VAC power requirement
- Interconnect feature for multi-fan shutdown
- Built-in short circuit protection



SD-D  
Duct Mount

### TEMPERATURE SENSOR KIT\*\*

- Duct temperature sensors
- Hermetically sealed 304SS probe
- Operating range -40°F to 210°F
- Easy installation with integral mounting plate



TS  
Duct Mount

### REMOTE DISPLAY\*\*

- Hand held or wall mount
- LED display
- Keypad for easy programming



RD-M  
Handheld or Wall Mount

### CO2 SENSORS\*

- Adjustable range from 400–2000 PPM
- Digital display
- 24VAC power requirement
- Self calibrates during periods of low occupancy
- Wall mount or add duct mount accessory
- Digital control output for use with standard controls



CO2-W  
Wall Mount

### MOTION OCCUPANCY SENSORS\*

- Passive infrared sensor
- Adjustable time-off delay to 30 minutes
- 24VAC power requirement
- Ceiling mount or directable wall mount
- Coverage floor space
  - Ceiling mount: 1500 sq. ft.
  - Wall mount: 2500 sq. ft.
- Major motion area
  - Ceiling mount: 50 ft. diameter
  - Wall mount: 68 x 50 ft.



MC-C  
Ceiling Mount

### BACNET FAN CONTROL\*\*\*

- Adds remote fan control functionally to standard controls unit
- Set fan on/off status and speed
- Local control without opening unit and/or BMS override via BACnet MS/TP
- 24VAC power requirement
- Wired connection to unit and BMS
- LCD display
- Wall mount



BACNETFC-W  
Wall Mount

### PRESSURE SENSORS (ROOM PRESSURE/ DUCT STATIC PRESSURE)\*\*

- With or without display
- Differential pressure transmitter
- 4–20 mA or field selectable 0–10 & 0.5V output signal
- Integral barbed tubing connections that fit 1/8" and 3/16" ID tubing



RPS-WOD/DPS-WOD  
Wall/Duct Mount without Display



# ACCESSORIES

## HOODED WALL VENT

- ♦ 10" and 12"
- ♦ Galvanized, paintable galvalume

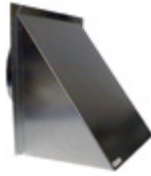

### FA10 PRESSURE DROP PERFORMANCE

### FA12 PRESSURE DROP PERFORMANCE

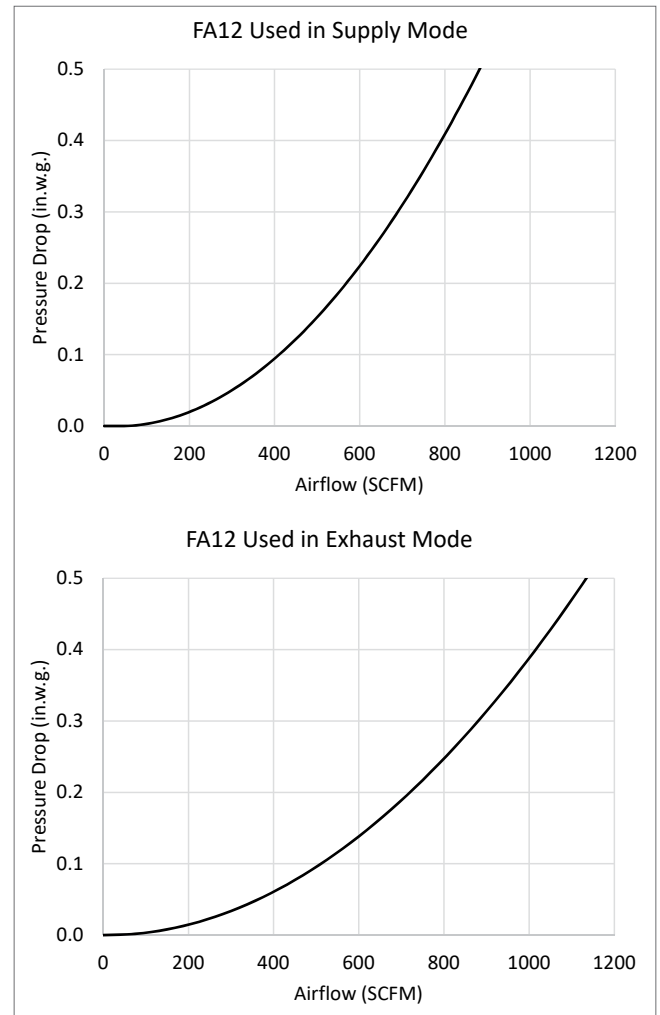
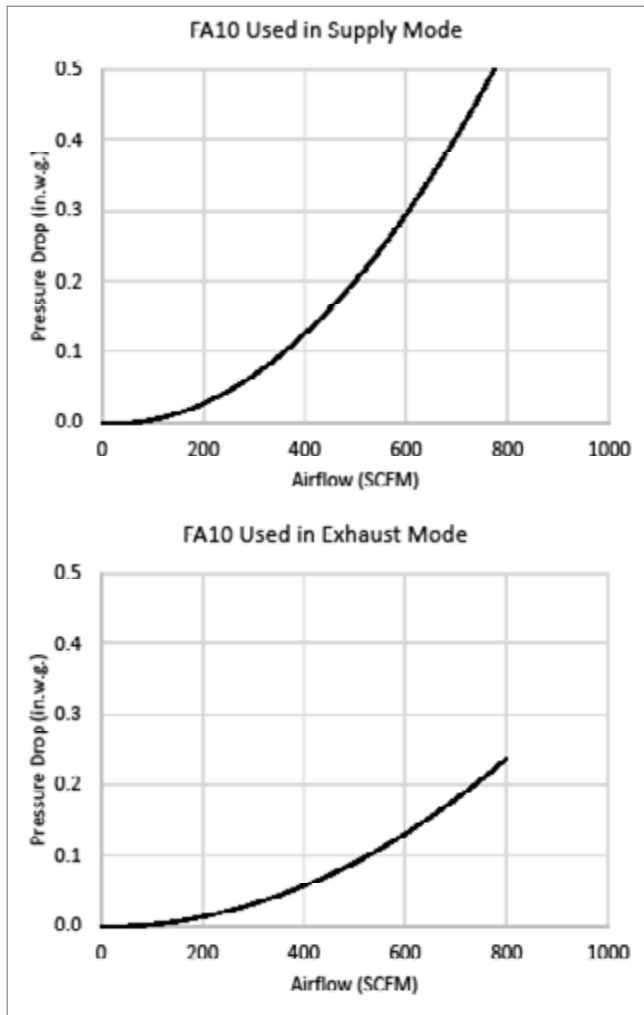

## AUTOMATIC BALANCING DAMPER

- ♦ 4", 5" and 6"



# ACCESSORIES

## LOUVERED WALL VENT

- 10" Round duct connection, 12" x 12"



### VW12 x 8 PRESSURE DROP PERFORMANCE

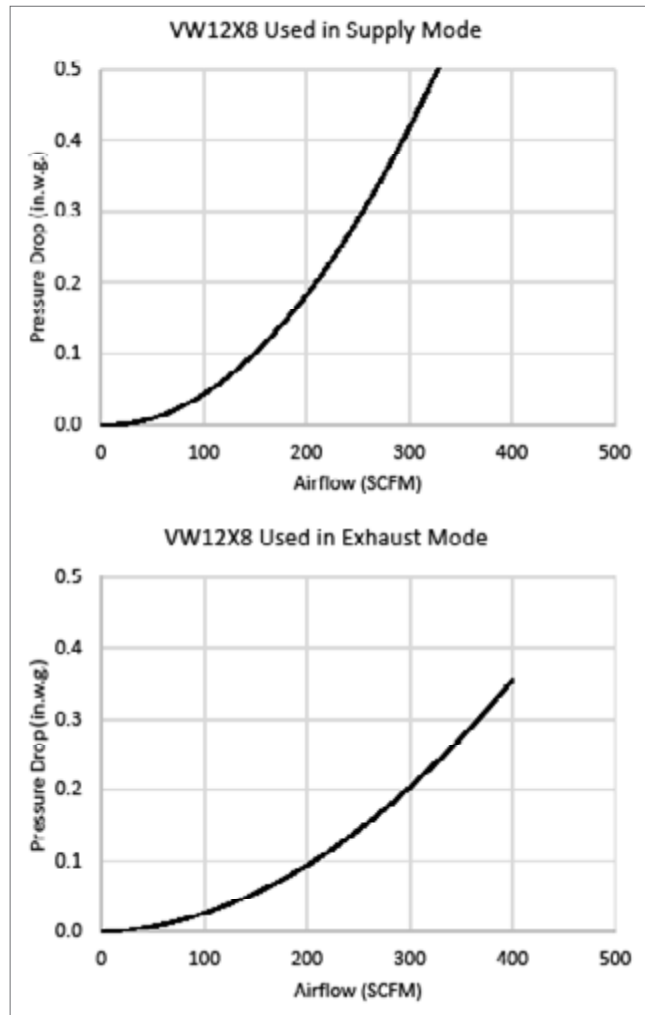

## BACKDRAFT DAMPER

- 8", 10" and 12"



### PRESSURE DROP PERFORMANCE

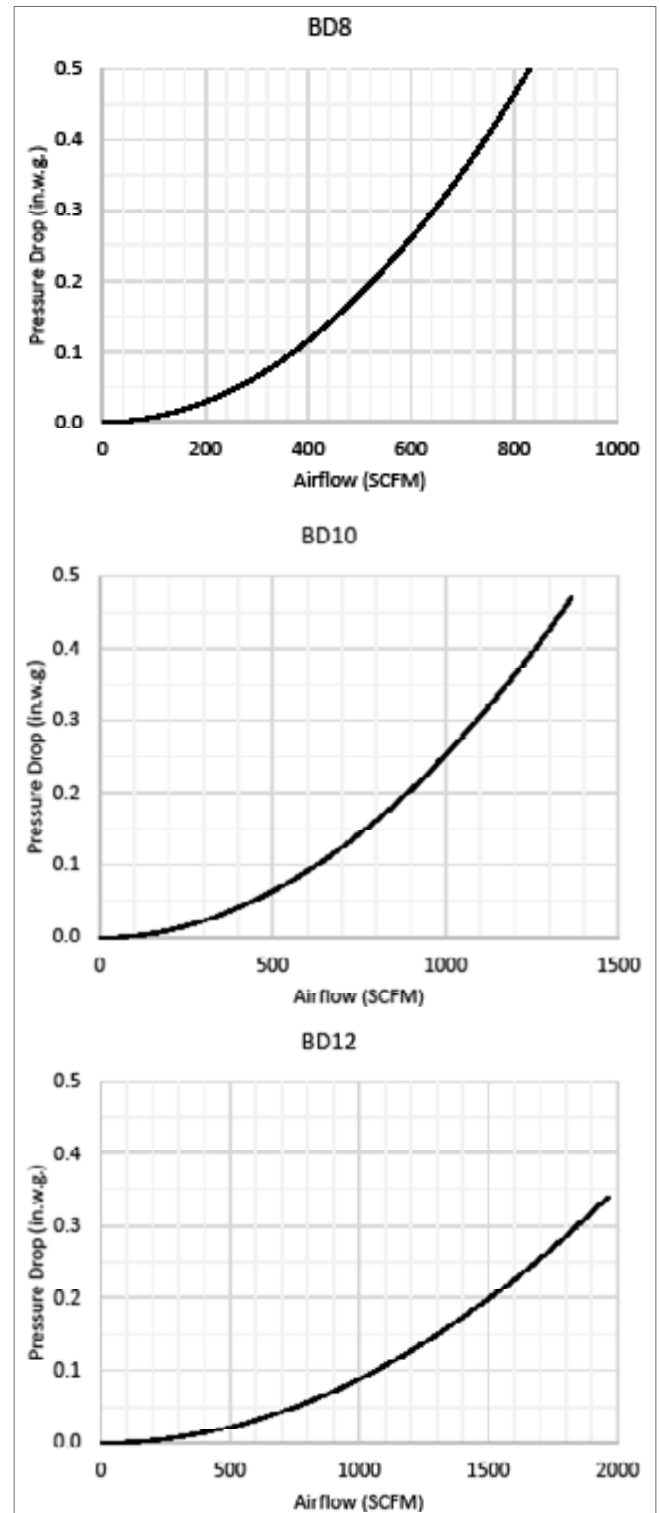

# ACCESSORIES

## ENGINEERED COMBO CURBS

Exclusively designed for select Trane (Voyager and Precedent) and Carrier (WeatherExpert, WeatherMaster, and WeatherMaker) models, RenewAire's engineered combo curb makes it easy to combine standard Air Handling Unit (AHU) rooftop applications with the benefits of RenewAire energy recovery ventilation. They eliminate the need for transitional ductwork between the RTU and the ERV, reducing the time and costs of installation. Simply install the curb, run the return and supply duct to the curb openings, then install the AHU and RenewAire units onto the curb. Additionally, the curbs allow the AHU unit to function in its standard operation as well as full-flow economizer modes.

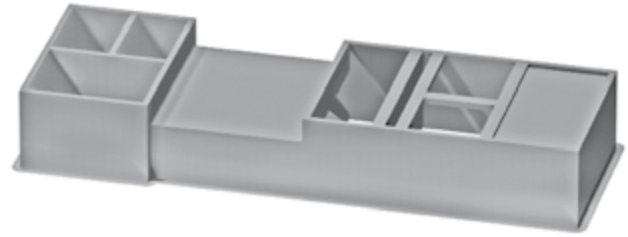

### Standard Construction

- ♦ Prime G-90, 18-gauge galvanized steel
- ♦ Fully welded and mitered corners (single piece curb lift)
- ♦ Base flange attachments for securing to the building structure
- ♦ 1 1/2" 3 lb. density fiberglass insulation
- ♦ Reinforced with cross channel supports on center
- ♦ Conforms to ASTM A653/A653M (standard specification for sheet metal)

### Available Options (Special Order)

- ♦ Seismic and/or wind load applications
- ♦ Pitched roof applications
- ♦ High vibration applications
- ♦ Custom curb heights
- ♦ Heavier metal gauges
- ♦ Aluminum liners

## ELECTRIC DUCT HEATERS

RenewAire offers the highest-efficiency energy recovery ventilators (ERVs) on the market. However, during winter conditions, supply air from the ERV may be less than optimal for space conditions. By adding RenewAire's round electric duct heater as an option to our single/multi-family and light commercial ERVs or configurable electric duct heaters as an accessory to our commercial ERVs, RenewAire can now heat supply air during cooler months to enhance indoor comfort, all via one package for ERVs and heaters from a single source.

### KEY BENEFITS

- ♦ **A single source reduces time and costs:** A single information source, a single purchase point and a single approval package for ERVs and heaters reduces design time and costs, and streamlines logistics for design engineers and contractors.
- ♦ **More flexibility:** RenewAire offers design engineers the capacity to specify ERVs with a matching heater to boost flexibility and provide heated air to a single space or multiple spaces.
- ♦ **Easy installation:** A ZERO clearance rating to combustibles allows designers and contractors to apply RenewAire heaters with less restrictions onsite.
- ♦ **Ultimate reliability:** RenewAire heaters come with our two-year warranty and unmatched reliability. Single-source responsibility offers contractors and end users peace of mind and a single call location for technical, start-up and commissioning questions.
- ♦ **Highly certified:**
  - RH Series:** CSA certified and evaluated to the applicable ANSI/UL and CSA Standards, for use in the U.S. and Canada.
  - EK Series:** UL Listed (UL1996 Standard) and CSA certified.

### RH SERIES

- ♦ Available on single/multi-family and light commercial units (some exceptions apply).



RH-W

### EK SERIES

- ♦ Available on all commercial units (some exceptions apply).
- ♦ Flippable 180 degrees



# RH SERIES

## ELECTRIC DUCT HEATER (1-11.5 kW) ACCESSORY



### ELECTRIC DUCT HEATER

### SPECIFICATIONS

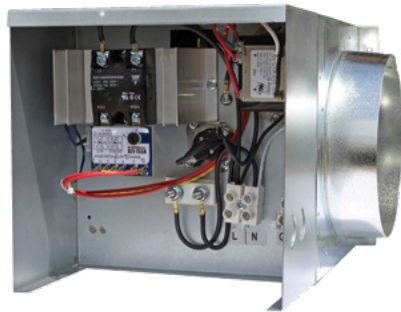

RH-D (Integral Thermostat)

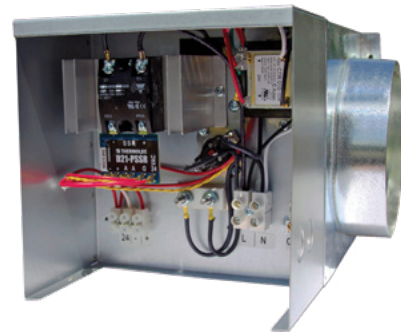

RH-W (Wall-Mount Thermostat)

**Heater Type:**  
Electric Duct Heater

---

**Typical kW Range:**  
1-11.5 kW (1, 2, 3, 4, 5, 6, 8, 10, 11.5 kW)

---

**Voltages & Phase:**  
Single phase: 120, 208 and 240V

---

**Control Voltage:**  
24VAC

---

**Controllable Output Temperature Range:**  
RH-D: 5 to 131° F  
RH-W: -3 to 130° F

**Standard Features:**  
Open-coil element  
High-grade, nickel-chrome element wire  
Thermostat: Integral (RH-D), Wall mount (RH-W)  
Modulating heat output (SCR control)  
Vertical or horizontal operation  
Automatic limit switch for primary over-temperature protection  
Manual reset limit switch for secondary over-temperature protection  
Airflow sensor  
Standard control transformer: 24VAC  
Corrosion-resistant galvanized steel  
Round duct collars  
High-voltage terminal block connections  
Grounding lug  
Mounting flanges

**Accessories:**  
Temperature sensor: Duct mount (DS-600)  
Digital time clock: wall mount (TC7D-W), in exterior enclosure (TC7D-E)  
Motion occupancy sensor/control: ceiling mount (MC-C), wall mount (MC-W)

**Note:** Electric duct heater designed for indoor ductwork installation only.

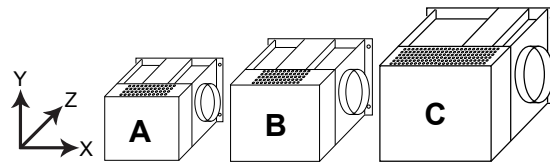

Duct Collar Sizes (in.)	kW	Volts	Size	Width (X) (in.)	Height (Y) (in.)	Depth (Z) (in.)	Max. Wt. (lbs.)
6	1, 2	120, 208, 240	A	11 1/2	8	11 1/2	10
8	3, 4, 5	208	B	11 1/2	10	13 1/2	15
8	3, 4, 5, 6	240	B	11 1/2	10	13 1/2	15
10	3, 4, 5	208	C	15 1/2	12	15 1/2	20
10	3, 4, 5, 6, 8, 10, 11.5	240	C	15 1/2	12	15 1/2	20
12	6, 8, 10, 11.5	240	C	15 1/2	12	15 1/2	20

### RH SERIES HEATER CAPACITY

Minimum Airflow (CFM)	Heater Capacity (kW)
30	1.00
60	2.00
90	3.00
120	4.00
150	5.00
180	6.00
240	8.00
300	10.00
345	11.50

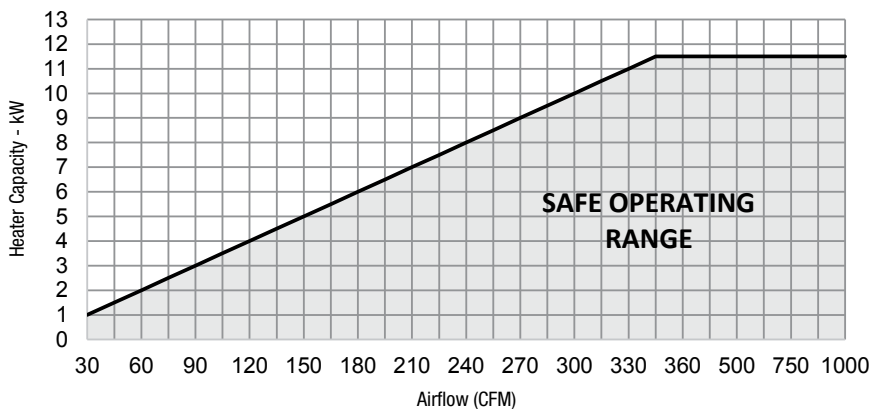

# RH SERIES CONFIGURATIONS

Duct Collar Size (in)	Voltage (1P, 60 Hz)	Heater Capacity (kW)	Line Amps	Wire Gauge	Fuse Amps	Thermostat	Part Number	Configuration
6	120	1	8.33	12	15	Integral	131320	RHD1120-6
						Wall Mount	131324	RHW1120-6
		2	16.66	12	20	Integral	131321	RHD2120-6
						Wall Mount	131325	RHW2120-6
	208	1	4.80	12	15	Integral	131352	RHD1208-6
						Wall Mount	131363	RHW1208-6
		2	9.61	12	15	Integral	131354	RHD2208-6
						Wall Mount	131365	RHW2208-6
	240	1	4.16	12	15	Integral	131353	RHD1240-6
						Wall Mount	131364	RHW1240-6
		2	8.33	12	15	Integral	131355	RHD2240-6
						Wall Mount	131366	RHW2240-6
8	208	3	14.42	12	20	Integral	131356	RHD3208-8
						Wall Mount	131367	RHW3208-8
		4	19.23	10	30	Integral	131357	RHD4208-8
						Wall Mount	131368	RHW4208-8
		5	24.03	10	30	Integral	131358	RHD5208-8
						Wall Mount	131369	RHW5208-8
	240	3	12.50	12	15	Integral	131322	RHD3240-8
						Wall Mount	131326	RHW3240-8
		4	16.66	12	20	Integral	131323	RHD4240-8
						Wall Mount	131327	RHW4240-8
		5	20.83	10	30	Integral	131359	RHD5240-8
						Wall Mount	131370	RHW5240-8
6	25.00	10	40	Integral	131360	RHD6240-8		
				Wall Mount	131371	RHW6240-8		
10	208	3	14.42	12	20	Integral	131336	RHD3208-10
						Wall Mount	131328	RHW3208-10
		4	19.23	10	30	Integral	131338	RHD4208-10
						Wall Mount	131330	RHW4208-10
		5	24.03	10	30	Integral	131340	RHD5208-10
						Wall Mount	131332	RHW5208-10
	240	3	12.50	12	15	Integral	131337	RHD3240-10
						Wall Mount	131329	RHW3240-10
		4	16.66	12	20	Integral	131339	RHD4240-10
						Wall Mount	131331	RHW4240-10
		5	20.83	10	30	Integral	131341	RHD5240-10
						Wall Mount	131333	RHW5240-10
	6	25.00	10	40	Integral	131342	RHD6240-10	
					Wall Mount	131334	RHW6240-10	
	240	8	33.33	8	50	Integral	131343	RHD8240-10
						Wall Mount	131348	RHW8240-10
		10	41.66	6	60	Integral	131361	RHD10240-10
						Wall Mount	131372	RHW10240-10
11.5		47.91	6	60	Integral	131362	RHD11-1/2240-10	
					Wall Mount	131373	RHW11-1/2240-10	
12	240	6	25.00	10	40	Integral	131344	RHD6240-12
						Wall Mount	131335	RHW6240-12
		8	33.33	8	50	Integral	131345	RHD8240-12
						Wall Mount	131349	RHW8240-12
		10	41.66	6	60	Integral	131346	RHD10240-12
						Wall Mount	131350	RHW10240-12
		11.5	47.91	6	60	Integral	131347	RHD11-1/2240-12
						Wall Mount	131351	RHW11-1/2240-12

# EK SERIES

## ELECTRIC DUCT HEATER



## ELECTRIC DUCT HEATER (1-175 KW) ACCESSORY



### SPECIFICATIONS

**Heater Type:**

Electric Duct Heater

**Typical KW Range:**

1-175 kW

**Standard Features:**

- A disconnecting magnetic control contactor per stage or each 48 Amp circuit within a stage
- Open-coil element
- Staged on/off
- Control terminal board
- Grounding lugs
- Automatic limit switch for primary over-temperature protection
- Manual reset limit switch for secondary over-temperature protection
- Non-adjustable airflow switch
- Standard control transformer: 24VAC
- Disconnect switch
- Duct thermostat with sensor for on/off control
- 60-20-20 (Ni/Cr/Fe) C Grade element wire with nickel-plated terminals
- Slip-in mount
- No left/right hand
- Vertical up/down flow

**Voltages & Phase:**

Single phase: 120, 208, 240, 277  
Three phase: 208, 240, 480, 600

**Control Voltage:**

24VAC

**Dimensions:**

Minimum: 8" x 8" (W x H)  
Maximum: 99" x 99" (W x H)

**Options:**

- Flange mount
- 80-20 (Ni/Cr) A Grade element wire with stainless steel terminals
- Recessed control box 1"
- Gasketed cover: dust tight
- Power fusing, standard for heaters drawing more than 48 Amps
- 2-stage
- Electronic step controller (4-stage)
- SCR (up to 96 Amps)
- SCR Vernier (over 96 Amps)
- Pilot light

**Accessory:**

- Room thermostat
- Room/duct thermostat-sensor kit for SCR control

**Note:** Electric duct heater designed for indoor ductwork installation only, and may be used for preheating in climates when desired.

**EK SERIES HEATER CAPACITY**

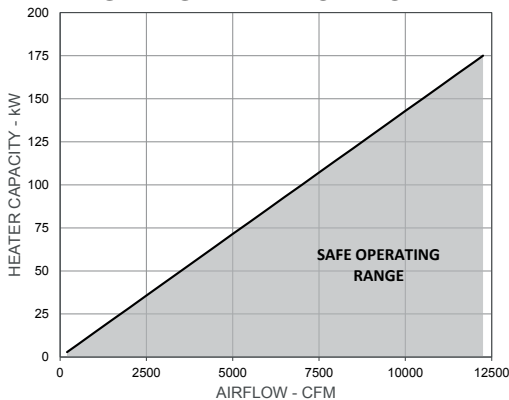

**PRESSURE DROP THROUGH HEATER**

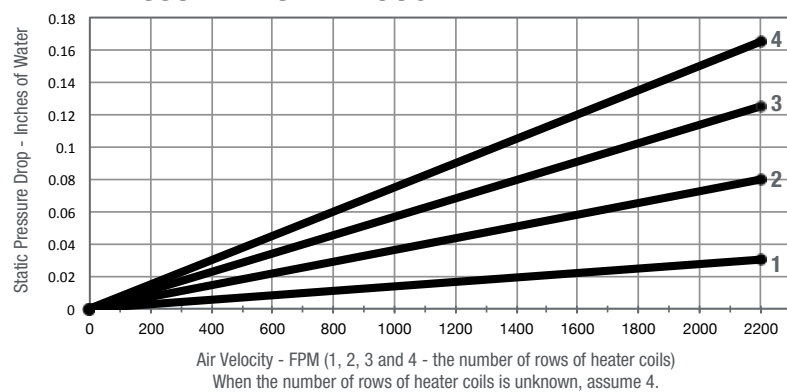

**FLIPPABLE CAPABILITIES**

Unique to the EK series, this unit has the ability to flip 180°. Additionally, EK heaters features both vertical up and vertical down airflow.

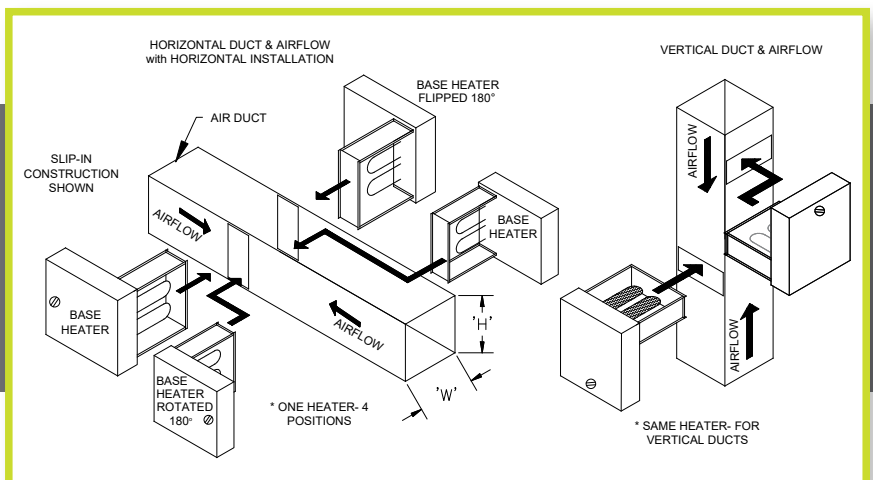

# GH INDOOR

## INDIRECT GAS-FIRED DUCT FURNACE ACCESSORY



### INDOOR INDIRECT GAS-FIRED DUCT FURNACE



Indoor IN-KI shown

### SPECIFICATIONS

**Heater Type:**  
Indirect Gas-Fired Duct Furnace

**Typical Input Capacity (MBH):**  
50, 75, 100, 125, 150, 175,  
200, 250, 300, 350, 400

**Standard Features:**  
Tubular heaters  
Indirect natural gas fired  
Indoor installation  
81% thermal efficiency  
Horizontal airflow  
Rated for elevations from 0–2,000 ft.  
409 stainless steel heat exchanger  
409 stainless steel burners  
Flue/combustion air: indoor models  
Vertical (separated indoor)  
Vertical top exhaust with louvered intake  
Direct spark ignition  
1-stage/2-stage gas controls  
Induced draft venting  
Terminal block for power and control wiring  
Automatic high limit safety shut-off  
Auxiliary manual high limit switch  
Combustion air pressure switch  
Air proving switch  
Combination gas valve with shutoff

**Standard Features (continued):**  
Flame rollout switch  
Manual shut off valve  
3/8" condensate drain connection

**Voltages & Phase:**  
Single phase: 120V, 230V

**Control Voltage:**  
24VAC

**Shipping:**  
Shipped loose with base unit and installed in the field

**Options:**  
Indirect propane fired fuel  
Elevation correction for elevation > 2,000 ft.  
304 stainless steel heat exchanger  
5:1 continuous electronic modulation for all furnaces  
10:1 continuous electronic modulation for furnaces  
200 MBH and larger  
Duct thermostat for modulation control  
Disconnect switch  
Power fusing

**Accessory:**  
Duct thermostat for 1-stage/2-stage control  
Duct thermostat for modulation control

### FLUE AND COMBUSTION AIR CONFIGURATION

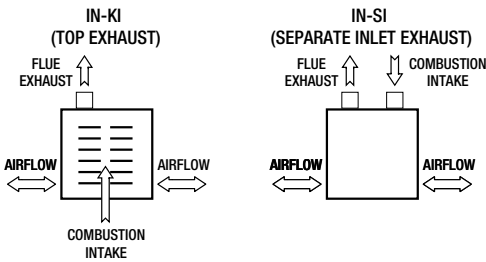

**Note:** The total equivalent length of vent pipe must not exceed 50 feet. If equivalent length exceeds 50 feet refer to IOM for recommendations.  
**Caution:** All indirect gas-fired duct furnaces to be installed downstream of the ERV and on the positive side of the supply fan.

### TEMPERATURE RISE AND PRESSURE DROP

FIGURE 1 GAS FURNACE 50–200 MBH

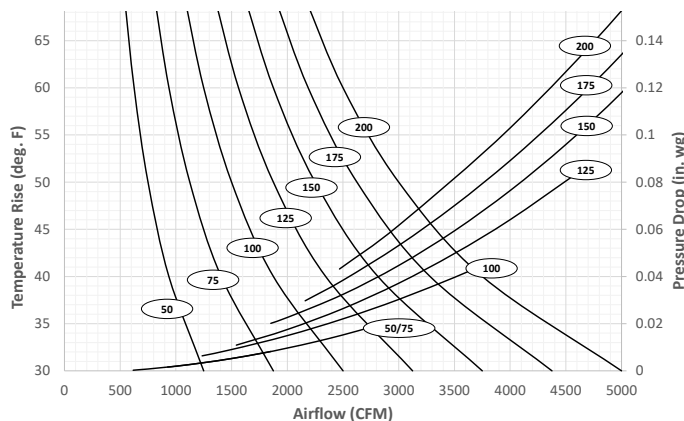
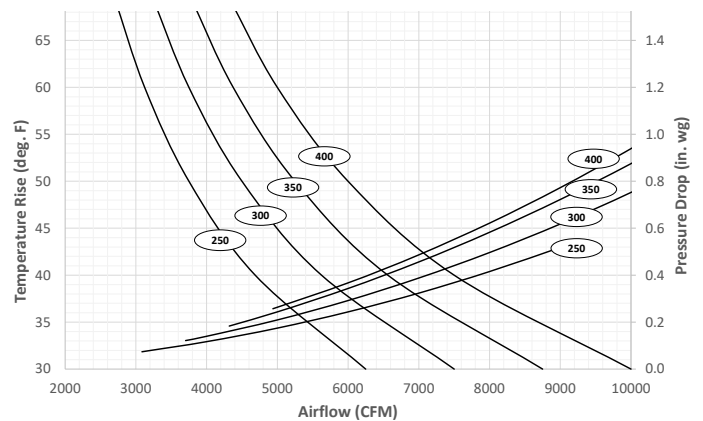
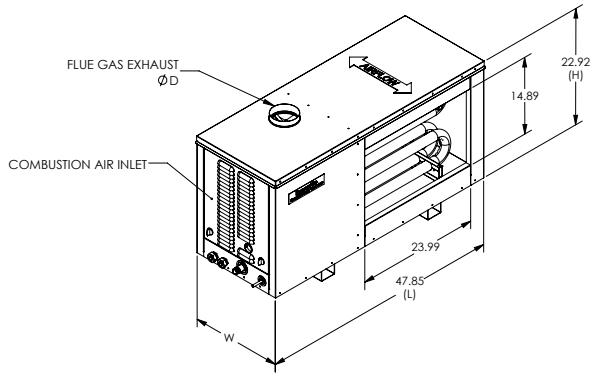

FIGURE 2 GAS FURNACE 250–400 MBH



**DUCT FURNACE DIMENSIONS**

**FIGURE 3 IN-KI (TOP EXHAUST INDOOR)**



**FIGURE 4 IN-SI (SEPARATE INLET EXHAUST INDOOR)**

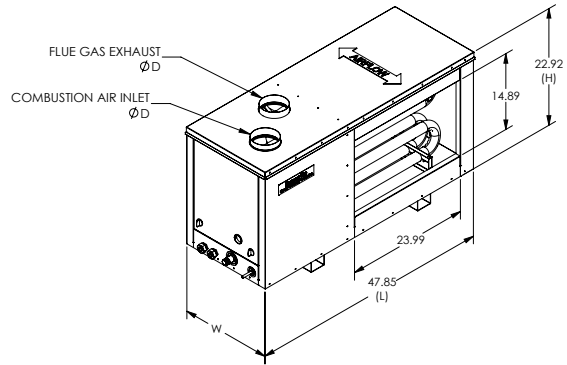

**INDIRECT GAS-FIRED DUCT FURNACE DIMENSIONS**

**UNIT DIMENSIONS WILL BE CHANGING STARTING JUNE 2023.**

**NEW DIMENSION DRAWINGS WILL BE CREATED AT TIME OF ORDER.**

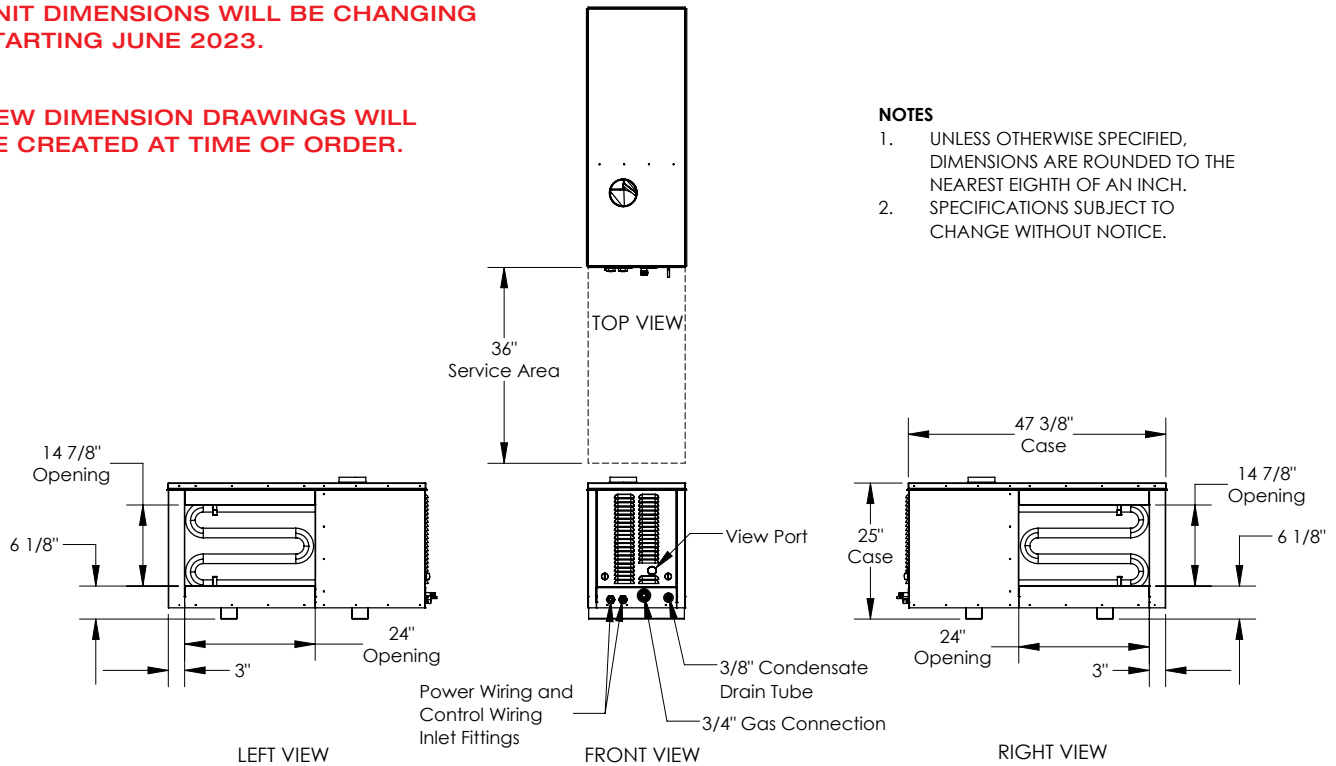

**NOTES**

1. UNLESS OTHERWISE SPECIFIED, DIMENSIONS ARE ROUNDED TO THE NEAREST EIGHTH OF AN INCH.
2. SPECIFICATIONS SUBJECT TO CHANGE WITHOUT NOTICE.



# GH OUTDOOR INDIRECT GAS-FIRED DUCT FURNACE ACCESSORY



## ROOFTOP INDIRECT GAS-FIRED DUCT FURNACE

## SPECIFICATIONS



Rooftop RT-NO shown

**Heater Type:**  
Indirect Gas-Fired Duct Furnace

**Typical Input Capacity (MBH):**  
50, 75, 100, 125, 150, 175,  
200, 250, 300, 350, 400

**Standard Features:**  
Tubular heaters  
Indirect natural gas fired  
Outdoor installation  
81% thermal efficiency  
Horizontal airflow  
Rated for elevations from 0–2,000 ft.  
409 stainless steel heat exchanger  
409 stainless steel burners  
Flue/combustion air: outdoor models  
Horizontal separated outdoor with hoods  
Vertical top exhaust with intake hood  
Direct spark ignition  
1-stage/2-stage gas controls  
Induced draft venting  
Terminal block for power and control wiring  
Automatic high limit safety shut-off  
Auxiliary manual high limit switch  
Combustion air pressure switch  
Air proving switch

**Standard Features (continued):**  
Combination gas valve with shutoff  
Flame rollout switch  
Manual shut off valve  
3/8" condensate drain connection

**Voltages & Phase:**  
Single phase: 120V, 230V

**Control Voltage:**  
24VAC

**Shipping:**  
Shipped loose with base unit and installed in the field

**Options:**  
Indirect propane fired fuel  
Elevation correction for elevation > 2,000 ft.  
304 stainless steel heat exchanger  
5:1 continuous electronic modulation for all furnaces  
10:1 continuous electronic modulation for furnaces  
200 MBH and larger  
Duct thermostat for modulation control  
Disconnect switch  
Power fusing

**Accessory:**  
Duct thermostat for 2-stage control  
Duct thermostat for modulation control  
Duct curb

## FLUE AND COMBUSTION AIR CONFIGURATION

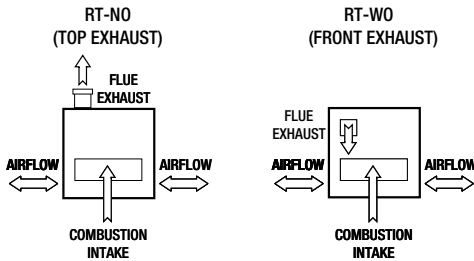

**Caution:** All indirect gas-fired duct furnaces to be installed downstream of the ERV and on the positive side of the supply fan.

## TEMPERATURE RISE AND PRESSURE DROP

FIGURE 1 GAS FURNACE 50–200 MBH

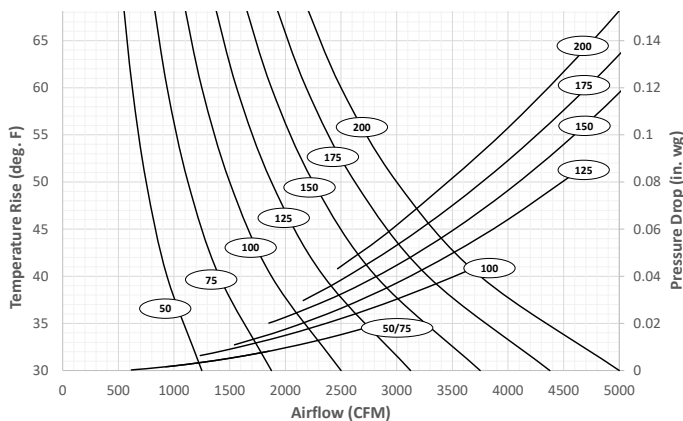
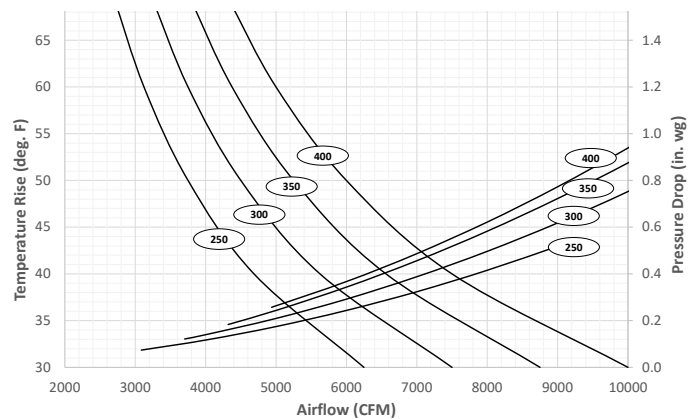
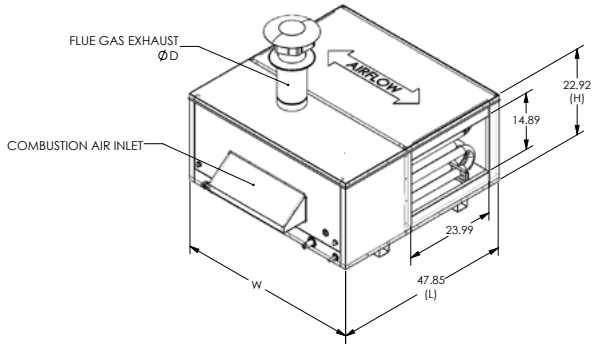

FIGURE 2 GAS FURNACE 250–400 MBH



**DUCT FURNACE DIMENSIONS**

**FIGURE 3 RT-NO (TOP EXHAUST OUTDOOR)**



**FIGURE 4 RT-WO (FRONT EXHAUST OUTDOOR)**

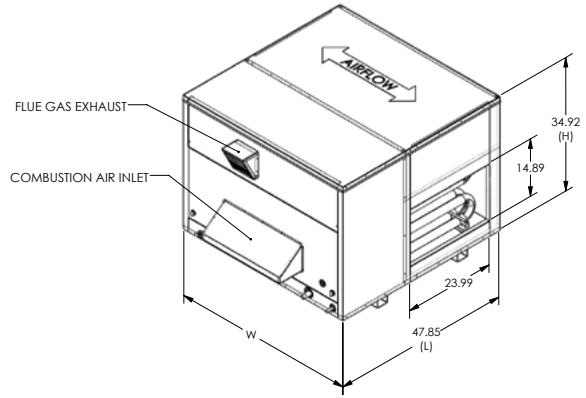

**INDIRECT GAS-FIRED DUCT FURNACE DIMENSIONS**

**UNIT DIMENSIONS WILL BE CHANGING STARTING JUNE 2023.**

**NEW DIMENSION DRAWINGS WILL BE CREATED AT TIME OF ORDER.**

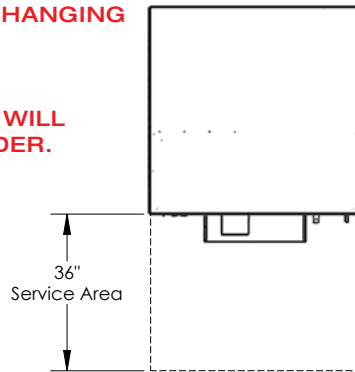

TOP VIEW

**NOTES**

1. UNLESS OTHERWISE SPECIFIED, DIMENSIONS ARE ROUNDED TO THE NEAREST EIGHTH OF AN INCH.
2. SPECIFICATIONS SUBJECT TO CHANGE WITHOUT NOTICE.

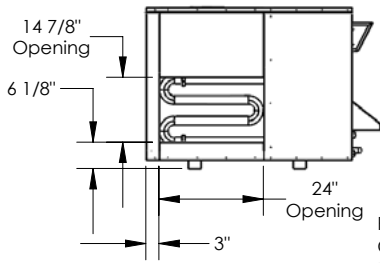

LEFT VIEW

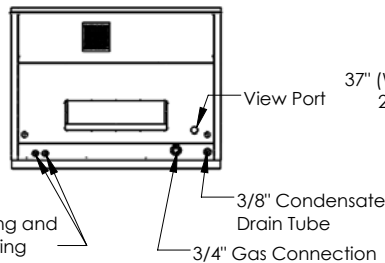

FRONT VIEW

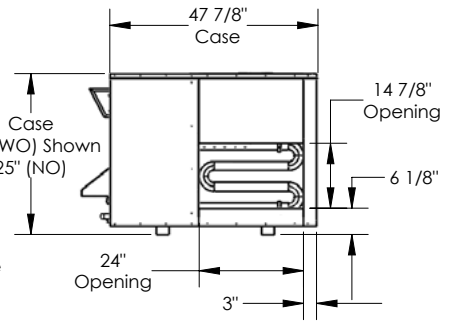

RIGHT VIEW

# LE SERIES MODEL CONFIGURATION GUIDE

Note: Not all options are available on every model.

<b>MODEL NUMBER</b>	<b>L</b>	<b>E</b>				<b>J</b>								-	-										
<b>DIGIT NUMBER</b>	1	2	3	4	5	6	7	8	9	10	11	12	13	14	15	16	17	18	19	20	21	22	23	24	25

<b>Digits 1-5:</b>	<b>Model</b>
"LE-6X"	
"LE-8X"	
"LE10X"	

<b>Digits 7-8:</b>	<b>Location</b>
"IN" = Indoor	
"RT" = Rooftop	

<b>Digit 9:</b>	<b>Orientation</b>
"V", "H" (Indoor Units)	
"V", "H", "R", "F" (Rooftop Units)	

<b>Digit 10:</b>	<b>Vibration Isolation</b>
"N" = Neoprene Isolators	
"S" = Spring Isolators	

<b>Digit 11:</b>	<b>Wall Type</b>
"S" = Single	
"D" = Double	

<b>Digit 12:</b>	<b>Phase (See Restriction 2)</b>
"1" = Single Phase	
"3" = Three Phase	

<b>Digit 13:</b>	<b>Voltage (see Restriction 1 &amp; 10)</b>
"4" = 460V	
"5" = 208-230V	
"8" = 575V	

<b>Digit 14:</b>	<b>FA Horsepower (see Restrictions 2, 3, &amp; 4)</b>
"D" = 3 HP Low Speed	
"F" = 3 HP Medium Speed	
"G" = 3 HP High Speed	
"J" = 5 HP Low Speed	
"K" = 5 HP Medium Speed	
"L" = 5 HP High Speed	
"M" = 7.5 HP Low Speed	
"N" = 7.5 HP Medium Speed	
"P" = 7.5 HP High Speed	
"Q" = 10 HP Medium Speed	
"R" = 10 HP High Speed	

<b>Digit 15:</b>	<b>EA Horsepower (see Restrictions 2, 3, &amp; 4)</b>
"D" = 3 HP Low Speed	
"F" = 3 HP Medium Speed	
"G" = 3 HP High Speed	
"J" = 5 HP Low Speed	
"K" = 5 HP Medium Speed	
"L" = 5 HP High Speed	
"M" = 7.5 HP Low Speed	
"N" = 7.5 HP Medium Speed	
"P" = 7.5 HP High Speed	
"Q" = 10 HP Medium Speed	
"R" = 10 HP High Speed	

<b>Digit 18:</b>	<b>Flow Control</b>
"-" = No Isolation Damper	
"D" = Motorized Damper both Airstreams	
"E" = Motorized Damper EA or RA Airstream	
"F" = Motorized Damper FA or OA Airstream	

<b>Digit 19:</b>	<b>Unit Control (see Restrictions 6, 7, 8, &amp; 11)</b>
"A" = Standard Unit Control Wiring	
"V" = Onboard VFD Both Airstreams with IE3 Premium Efficiency Motors	
"W" = Onboard VFD Both Airstreams with IE5+ Ultra Premium Efficiency Motors	

<b>Digit 20:</b>	<b>Disconnect</b>
"N" = Non-Fused (Standard)	
"F" = Fused	

<b>Digit 21:</b>	<b>Unit Control Enhancements</b>
"T" = Transformer with Isolation Relay (Standard)	
"1" = Enhanced Controls	
"2" = Premium Controls	
"3" = Enhanced Controls with BACnet License	
"4" = Premium Controls with BACnet License	

<b>Digit 22:</b>	<b>Filter Options (see Restriction 9)</b>
"-" = None (Standard)	
"F" = Filter Monitor Both Airstreams	

<b>Digit 23:</b>	<b>Flexible Packaging</b>
"A" = Assembled (single piece flat bed)	
"M" = Modular (two pieces for enclosed trailer)	

<b>Digit 24:</b>	<b>Paint and Customization</b>
"-" = None	
"W" = White Paint	
"C" = Custom Paint	
"X" = Custom Unit	

<b>Digit 25:</b>	<b>Safety Listing (see Restriction 5)</b>
"L" = Listed	
"N" = Non-Listed	

\*NOTES:  
Digit 6 "J" = G5 Core Type. Digits 16 and 17 are not used in these models.

For Technical Support E-mail: [RenewaireSupport@renewaire.com](mailto:RenewaireSupport@renewaire.com)  
To Place an Order E-mail: [RenewaireOrders@renewaire.com](mailto:RenewaireOrders@renewaire.com)

# LE SERIES MODEL CONFIGURATION GUIDE

Note: Not all options are available on every model.

MODEL NUMBER	L	E				J										-	-											
DIGIT NUMBER	1	2	3	4	5	6	7	8	9	10	11	12	13	14	15	16	17	18	19	20	21	22	23	24	25			

<b>Restrictions:</b>	<ol style="list-style-type: none"> <li>1: Voltage Codes "4" &amp; "8" only available with Phase Code "3" (Three-Phase).</li> <li>2: Phase Code "1" only available in Motor Codes "D", "F", &amp; "G".</li> <li>3: Motor Code "P" (7.5 HP High Speed) not available in LE-6X.</li> <li>4: Motor Codes "Q" &amp; "R" (all 10 HP Speeds) not available in LE-6X &amp; LE-8X.</li> <li>5: Some units with Customization Code "X" are not safety listed.</li> <li>6: Unit Control Code "V" &amp; "W" only available with Motor Codes "G", "L", &amp; "N" in LE-6X.</li> <li>7: Unit Control Code "V" &amp; "W" only available with Motor Codes "G", "L", &amp; "P" in LE-8X.</li> <li>8: Unit Control Code "V" &amp; "W" only available with Motor Codes "G", "L", "P", &amp; "R" in LE10X.</li> <li>9: Filter Code "F" not available with Unit Control Enhancements Codes "1", "2", "3", &amp; "4". Filter Monitor is provided with those options.</li> <li>10: Voltage Code "8" (575V) not available with Unit Control Code "W" (Onboard VFD Both Airstreams with IE5+ Ultra Premium Efficiency Motors).</li> <li>11: Unit Control Code "W" (Onboard VFD Both Airstreams with IE5+ Ultra Premium Efficiency Motors) not available with Voltage Code "8" (575V).</li> </ol>
----------------------	---

For Technical Support E-mail: [RenewaireSupport@renewaire.com](mailto:RenewaireSupport@renewaire.com)  
 To Place an Order E-mail: [RenewaireOrders@renewaire.com](mailto:RenewaireOrders@renewaire.com)

# EK SERIES ELECTRIC DUCT HEATER CONFIGURATION GUIDE

Note: Not all options are available on every model.

MODEL NUMBER

<b>E</b>	<b>K</b>	-										<b>C</b>										<b>S</b>	-	
----------	----------	---	--	--	--	--	--	--	--	--	--	----------	--	--	--	--	--	--	--	--	--	----------	---	--

DIGIT NUMBER

1	2	3	4	5	6	7	8	9	10	11	12	13	14	15	16	17	18	19	20	21	22	23	24	25
---	---	---	---	---	---	---	---	---	----	----	----	----	----	----	----	----	----	----	----	----	----	----	----	----

<b>Digits 1–2:</b>	Heater Type
"EK" = Electric Heater (Standard)	

<b>Digits 4–5:</b>	Width in Inches (see Restriction 1)
08–99	

<b>Digits 6–7:</b>	Height in Inches (see Restriction 2)
08–99	

<b>Digits 8–10:</b>	Capacity in kW (see Restrictions 3, 4, & 5)
001–175	

<b>Digit 11:</b>	Mount
"S" = Slip In (Standard)	
"F" = Flanged	

<b>Digit 12:</b>	Element Style
"C" = Open Coil (Standard)	

<b>Digit 13:</b>	Element Material
"C" = 60-20-20 Ni-Cr-Fe with Nickel Plate Terminal Pins (Standard)	
"A" = 80-20 Ni-Cr with Stainless Steel Terminal Pins	

<b>Digit 14:</b>	Airflow Orientation
"H" = Horizontal (Standard)	
"V" = Vertical	

<b>Digit 15:</b>	Control Box Offset
"L" = Left Hand (Standard)	
"R" = Right Hand	

<b>Digit 16:</b>	Control Box Recessed
"." = None (Standard)	
"R" = Recessed 1"	

<b>Digit 17:</b>	Control Box Dust Tight
"." = None (Standard)	
"D" = Dust Tight	

<b>Digit 18:</b>	Voltage (see Restrictions 7 & 8)
"1" = 120V	
"2" = 208V	
"3" = 240V	
"4" = 480V	
"8" = 600V	
"9" = 277V	

<b>Digit 19:</b>	Phase
"1" = Single-Phase	
"3" = Three-Phase	

<b>Digit 20:</b>	Power Fusing (see Restriction 9)
"." = None	
"F" = Fusing	

<b>Digit 21:</b>	Element Material
"1" = Single (Standard)	
"2" = 2-Stage	
"4" = 4-Stage	

<b>Digit 22:</b>	Control Voltage
"S" = 24VAC	

<b>Digit 23:</b>	Control Type (see Restrictions 10, 11, & 12)
"D" = Staged with Thermostat and Sensor (Standard)	
"E" = Electronic Step Control with Thermostat and Sensor	
"S" = SCR (control by others)	
"V" = SCR with Thermostat and Sensor	

<b>Digit 25:</b>	Pilot Light (See Restriction 13)
"N" = None (Standard)	
"L" = Light	

**\*NOTES:**

Digits 3 and 24 are not used in this model.  
 All heaters come with standard features: Disconnect Switch, Air Flow Switch (non adjustable), Control Transformer  
 Descriptions of feature and options are found in the installation and operation manual.

**Restrictions:**

- 1: Width inches entered as a whole number.
- 2: Height inches entered as a whole number.
- 3: Heater density should be less than 30kW/ft².  $DENSITY = \frac{HEATER\ CAPACITY\ (kW)}{(W \times H) / 144} < 30$
- 4: Heater capacity kW entered as a whole number.
- 5: Formulas for calculating kW and temperature rise:  $kW = \frac{CFM \times \Delta T}{3150}$     $\Delta T = \frac{kW \times 3150}{CFM}$
- 7: Voltage Codes "1" & "9" only available with Phase Code "1" (Single-Phase).
- 8: Voltage Codes "4" & "8" only available with Phase Code "3" (Three-Phase).
- 9: Power Fusing Code "F" required when amperage is > 48A. (based on kW and voltage)
- 10: Control Type Code "D" only available with Stage Code "1" & "2".
- 11: Control Type Code "E" only available with Stage Code "4".
- 12: Control Type Code "S" & "V" only available with Stage Code "1", unless amperage is greater than or equal to 96A, then Stage Code "4" is automatically selected.
- 13: Pilot Light Code "L" only available with Control Type Code "D".
3. Power Fusing Code "F" only available with Disconnect Switch Code "D". Power Fusing Code "F" always selected when Disconnect Switch Code "D" is selected.

For Technical Support E-mail: [RenewaireSupport@renewaire.com](mailto:RenewaireSupport@renewaire.com)  
 To Place an Order E-mail: [RenewaireOrders@renewaire.com](mailto:RenewaireOrders@renewaire.com)



# GH SERIES INDIRECT GAS-FIRED DUCT FURNACE CONFIGURATION GUIDE

Note: Not all options are available on every model.

MODEL NUMBER

G	H	-												H	T					1	-	S	-	-
---	---	---	--	--	--	--	--	--	--	--	--	--	--	---	---	--	--	--	--	---	---	---	---	---

DIGIT NUMBER

1	2	3	4	5	6	7	8	9	10	11	12	13	14	15	16	17	18	19	20	21	22	23	24	25
---	---	---	---	---	---	---	---	---	----	----	----	----	----	----	----	----	----	----	----	----	----	----	----	----

<b>Digits 1-2:</b>	Model
"GH"	= Gas Furnace 50-400 MBH

<b>Digits 4-5:</b>	Location
"IN"	= Indoor
"RT"	= Rooftop

<b>Digits 6-7:</b>	Vent Location
"SI"	= Separated Top Indoor
"KI"	= Top Exhaust Indoor
"WO"	= Front Exhaust Outdoor
"NO"	= Top Exhaust Outdoor

<b>Digits 8-10:</b>	Input Capacity in MBH
"050", "075", "100", "125", "150", "175", "200", "250", "300", "350", "400"	

<b>Digit 11:</b>	Fuel Type
"N"	= Natural Gas (Standard)
"P"	= Propane

<b>Digits 12-13:</b>	Tube Material
"SS"	= 409 Stainless Steel (Standard)
"CS"	= 304 Stainless Steel

<b>Digit 14:</b>	Airflow Orientation
"H"	= Horizontal

<b>Digit 15:</b>	Thermal Efficiency
"T"	= 81%

<b>Digit 16:</b>	Elevation
"S"	= 0-2000' (Standard)
"2"	= 2001'-3000'
"3"	= 3001'-4000'
"4"	= 4001'-5000'
"5"	= 5001'-6000'
"6"	= 6001'-7000'
"Y"	= 7001' and above

<b>Digit 17:</b>	Disconnect Switch
"N"	= None (Standard)
"D"	= Disconnect Switch

<b>Digit 18:</b>	System/Inducer Voltage
"1"	= 115V
"3"	= 230V

<b>Digit 19:</b>	Phase
"1"	= Single Phase

<b>Digit 20:</b>	Power Fusing (see Restriction 2)
"N"	= None
"F"	= Fusing

<b>Digit 22:</b>	Control Voltage
"S"	= 24VAC

<b>Digit 23</b>	Control Type (see Restriction 1)
"T"	= Two Stage High/Low with Thermostat (Standard)
"S"	= Single Stage On/Off with Thermostat
"E"	= Modulating 5:1 (Natural Gas)/3:1 (Propane) with Thermostat
"W"	= Modulating 10:1 (Natural Gas)/6:1 (Propane) with Thermostat
"2"	= Two Stage High/Low without Thermostat
"1"	= Single Stage On/Off without Thermostat
"M"	= Modulating 5:1 (Natural Gas)/3:1 (Propane) without Thermostat
"V"	= Modulating 10:1 (Natural Gas)/6:1 (Propane) without Thermostat

**\*NOTES:**

Digits 3, 21, 24, & 25 are not used in this model.  
 All heaters come with standard features: Air Proving Switch, Auxiliary High Temperature Limit Switch  
 Descriptions of feature and options are found in the installation and operation manual.

<b>Restrictions:</b>
1. Control Type Code "V" & "W" not available with Input Capacity in MBH Codes "050", "075", "100", "125", "150", & "175".
2. Power Fusing Code "F" only available with Disconnect Switch Code "D". Power Fusing Code "F" always selected when Disconnect Switch Code "D" is selected.

For Technical Support E-mail: [RenewaireSupport@renewaire.com](mailto:RenewaireSupport@renewaire.com)  
 To Place an Order E-mail: [RenewaireOrders@renewaire.com](mailto:RenewaireOrders@renewaire.com)





# INDOOR AIR QUALITY MATTERS

- ◆ **Deficient IAQ** is an EPA **top-five** health risk
- ◆ People spend **90%** of their **time indoors**
- ◆ **Indoor air** can be 2–5 times and up to 100 times **more polluted than outdoor air**
- ◆ **ERVs improve IAQ** and **reduce costs**

## INCREASED VENTILATION BENEFITS



---

## TECHNICAL SALES SUPPORT

The goal of our technical-support team is to provide the **BEST CUSTOMER SERVICE** in the HVAC industry. You can count on our knowledgeable and seasoned staff for all your technical, application and service needs, and we'll respond quickly and effectively to answer any of your questions.



**TECHNICAL SUPPORT:**  
[RenewAireSupport@RenewAire.com](mailto:RenewAireSupport@RenewAire.com)



**PHONE:**  
1.800.627.4499



**TO PLACE AN ORDER:**  
[CORES.RenewAire.com](http://CORES.RenewAire.com)  
or  
[RenewAireOrders@RenewAire.com](mailto:RenewAireOrders@RenewAire.com)