

⚠ WARNING

RISK OF FIRE, ELECTRIC SHOCK, OR INJURY. OBSERVE ALL CODES AND THE FOLLOWING:

1. Before servicing or cleaning the unit, switch power off at disconnect switch or service panel and lock-out/tag-out to prevent power from being switched on accidentally. More than one disconnect switch may be required to de-energize the equipment for servicing.
2. This installation manual shows the suggested installation method. Additional measures may be required by local codes and standards.
3. Installation work and electrical wiring must be done by qualified professional(s) in accordance with all applicable codes, standards and licensing requirements.
4. Any structural alterations necessary for installation must comply with all applicable building, health, and safety code requirements.
5. This unit must be grounded.
6. Use the unit only in the manner intended by the manufacturer. If you have questions, contact the manufacturer.
7. When cutting or drilling into unit, wall or ceiling, do not damage electrical wiring and other hidden utilities.
8. Do not re-wire the Variable Frequency Drive(s) (VFD) to control more than one motor per VFD.
9. Do not operate the motors in this unit above the motor's rated full load amps (FLA) as indicated on the unit's nameplate. Follow all local codes.

⚠ WARNING

Capacitors in VFDs Retain Charge

Allow 3 minutes after shutting off power to the VFDs to allow the capacitors in the VFD to fully discharge. Do not connect or disconnect wires at the VFD without waiting 3 minutes.

⚠ WARNING

DANGER OF MOTOR OVERLOAD LEADING TO SMOKE AND FIRE!

Do not change parameters L3-02 and L3-06 from RenewAire default settings, which should be set to no more than 125% of the ratio of Motor FLA / VFD FLA. These parameters set the limits of output current provided by the VFD.

⚠ CAUTION

DO NOT OPERATE VFD IN CONDITIONS OUTSIDE OF TEMPERATURE LIMITS. The manufacturer's published ambient temperature limits for V1000 VFDs are 14°F to 122°F. RenewAire has performed extensive ambient temperature validation tests that demonstrates the VFDs may be operated at a lower temperature limit for starting the VFD down to -22°F. It is recommended that the VFD not be operated for prolonged periods at temperatures below 14°F to ensure longevity of the VFD. As RenewAire commercial ERVs are VFD ready, consider field installing VFDs in a climate controlled indoor electrical cabinet when ERV is installed in extreme climates.

1.0 OVERVIEW	4
1.1 ABOUT YASKAWA VARIABLE FREQUENCY DRIVES (VFDS)	4
1.2 PLANNING YOUR INSTALLATION	4
1.2.1 “ON” and “SPEED” Signals	5
1.2.2 Principles of External Control	5
1.2.3 Connecting External Controls	5
1.2.4 Wire Routing	5
1.2.5 Purpose of Providing Keypad	6
2.0 INSTALLATION	7
2.1 WIRING OPTIONS	7
2.1.1 “ON” Signal Connections	7
2.2 WIRING SCHEMATICS	7
2.2.1 Analog Inputs to Provide the “SPEED” Signal	9
2.2.2 Wiring Two VFDs for Leader-Follower Operation	9
2.2.3 Using VFD Presets for the “SPEED” Signals	10
2.2.4 Use with a CO2 Controller	11
3.0 OPERATION	12
3.1 INITIAL START-UP	12
3.1.1 To Start ERV	12
3.1.2 Motor Protection by the VFD(s)	12
3.2 SETTINGS	13
3.2.1 VFD Parameter Overview	13
3.2.2 To View All VFD Parameters	13
3.2.3 To Change VFD Parameters	13
3.2.4 To Change VFD Parameters (when parameters are unlocked)	14
3.2.5 To View Only Changed VFD Parameters	14
3.2.6 Summary Table of Commonly Used Parameters with Standard AC Induction Motors	15
3.2.7 208V Standard AC Motor Specific VFD Parameter Settings	17
3.2.8 460V Standard AC Motor Specific VFD Parameter Settings	18
3.2.9 RenewAire Yaskawa Parameter Settings—EC Motors	19
3.2.10 230V EC-Titanium Motor Specific VFD Parameter Settings*	21
3.2.11 460V EC-Titanium Motor Specific VFD Parameter Settings*	21
3.2.12 To Reset VFD Parameters to Factory Settings using Keypad	22
3.2.13 Scaling and Response to Analog Inputs	23
3.2.14 Additional Job Information Needed	23
3.2.15 Application Example: CO2 Controller	23
3.2.16 Example of VFD Scaling	26
4.0 FACTORY ASSISTANCE	27
4 TABLE OF ILLUSTRATIONS	
Figure 1.2.0 Yaskawa Keypad Buttons	6
Figure 2.2.0 Connection of “ON” Signals to Low-Voltage Terminal Strip in ERV E-box	7
Figure 2.2.1 Factory Control Wiring: “ON” Signals Connected to Each VFD	8
Figure 2.2.2 Alternate Control Wiring	8
Figure 2.2.3 Examples of Analog Input Connections	9
Figure 2.2.4 Leader-Follower Connection	9
Figure 2.2.5 Use of 3 Switches to Command the VFD to Operate at Any of 3 Pre-set Speeds (SP4T Switch Alternatively)	10
Figure 2.2.6 Example of Operation of 2 VFDs by a CO2 Controller	11

1.0 OVERVIEW

1.1 ABOUT YASKAWA VARIABLE FREQUENCY DRIVES (VFDs)

This manual supplements RenewAire's standard Installation and Operation Manuals, which do not include information on units equipped with Yaskawa VFDs. RenewAire uses Yaskawa VFDs for some models, typically those using a 208-230VAC or 460VAC power supply.

Yaskawa V1000 VFDs are supplied in both indoor and outdoor Energy Recovery Units (ERVs) and have the ability to include a BACnet building communication protocol interface.

For complete ERV installation you will also need:

- **Standard Installation and Operation Manual for the ERV**—physical installation and duct connection, maintenance procedures, etc.
- **Supplemental Wiring Schematic Manual**—complete unit wiring diagrams.
- **User's Manual V1000**—Yaskawa's Manuals—User Guides.
More detailed information is available online in the Downloads page at <https://www.yaskawa.com/downloads>.

1.2 PLANNING YOUR INSTALLATION

⚠ WARNING

RISK OF FIRE, ELECTRIC SHOCK, OR INJURY.
OBSERVE ALL CODES AND THE FOLLOWING:

1. Before servicing or cleaning the unit, switch power off at disconnect switch or service panel and lock-out/tag-out to prevent power from being switched on accidentally. More than one disconnect switch may be required to de-energize the equipment for servicing.
2. This installation manual shows the suggested installation method. Additional measures may be required by local codes and standards.
3. Installation work and electrical wiring must be done by qualified professional(s) in accordance with all applicable codes, standards and licensing requirements.
4. Any structural alterations necessary for installation must comply with all applicable building, health, and safety code requirements.
5. This unit must be grounded.
6. Use the unit only in the manner intended by the manufacturer. If you have questions, contact the manufacturer.
7. When cutting or drilling into unit, wall or ceiling, do not damage electrical wiring and other hidden utilities.
8. Do not re-wire the VFD(s) to control more than one motor per VFD.
9. Do not operate the motors in this unit above the motor's rated full load amps (FLA) as indicated on the unit's nameplate. Follow all local codes.



NOTE: VFD(s) in this unit can be operated in many ways. This Manual provides only an outline of common methods.

⚠ CAUTION

DO NOT OPERATE VFD IN CONDITIONS OUTSIDE OF TEMPERATURE LIMITS. The manufacturer's published ambient temperature limits for V1000 VFDs are 14°F to 122°F. RenewAire has performed extensive ambient temperature validation tests that demonstrates the VFDs may be operated at a lower temperature limit for starting the VFD down to -22°F. It is recommended that the VFD not be operated for prolonged periods at temperatures below 14°F to ensure longevity of the VFD. As RenewAire commercial ERVs are VFD ready, consider field installing VFDs in a climate controlled indoor electrical cabinet when ERV is installed in extreme climates.

1.2.1 “ON” and “SPEED” Signals

VFD operation in this unit is dependent on two signals: an “ON” signal and a “SPEED” (or REFERENCE) signal. The sources and types of these signals can vary. If the ERV is equipped with dampers, the “ON” signal to the VFD comes from the end switch on the damper. If the ERV is not equipped with dampers, the “ON” signal comes from an external control connected directly to the VFD. When an “ON” signal is received by the VFD, it starts the motor. The VFD then operates the blower at the speed established by the “SPEED” signal. The “SPEED” signal is often provided by an external control, but in some applications “pre-set” speeds are set inside the VFD and are selected by external switches or relays.

1.2.2 Principles of External Control

This ERV can be operated by various external control devices including remote switch or relay, digital time clock with relay, occupancy sensor with relay, and carbon dioxide sensor with relay and analog output. These devices are commonly known as 2-wire, 3-wire, and 4-wire devices. A Building Management System (BMS) can control this ERV through relay contacts and with 0–10vdc or 4–20mA analog inputs.

The external control devices can be connected to this ERV to operate each blower independently or in a leader-follower configuration. In leader-follower mode, a single external switch or relay calls for operation and the leader VFD sets “SPEED” to internal presets, or in response to an analog input signal. The follower VFD then operates at either exactly the same speed, at an offset above or below the leader’s speed, or at a scaled speed.

The VFD’s are pre-programmed at the factory so only a few parameters need change for a specific installation.

1.2.3 Connecting External Controls

If this ERV is equipped with damper(s), the “ON” signal is connected to the terminal strip in the electrical enclosure (e-box). If this ERV is not equipped with damper(s), and has 2 VFDs, the “ON” signal is connected directly to the VFDs. The “SPEED” signals are always connected directly to the VFD(s).

1.2.4 Wire Routing

Route input power cables, motor cables and control cables separately to decrease electromagnetic interference caused by the rapid changes in the drive output voltage. Where control cables must cross power cables make sure that they are arranged at an angle as near to 90 degrees as possible.

Power cables and control cables can be brought into the bottom of the e-box attached to the ERV unit or through the bottom of the unit itself. There are plugged holes to run control wires and power wires between the electrical box and the unit interior, marked on the interior of the ERV unit and another plugged hole in the unit compartment divider to run wires to VFDs in the other airstream compartment if needed.

In some configurations the VFD and/or VFD protective guard may need to be removed to access the control wire hole plug to run wires. A label is located in the ERV on the left interior wall indicating the power and control wire hole plug locations. Bring wires out from the top or bottom of the VFD mounting bracket and not through the mounting bracket window when routing wires if the VFD is mounted over the hole plug.

After the wires are run, apply caulk around the wires at wire bushings used between the electrical box and ERV unit and between compartments in the unit to prevent air leakage between these compartments.

1.2.5 Purpose of Providing Keypad

Each VFD has a keypad which is accessible at the e-box while the unit is operating.

Parameter adjustments, VFD operation status, and manual control of the VFD are all functions of the keypad.

VFD is factory programmed to cover most needs but some parameters will need to be set to interact with the external control system.

Access the keypad(s) through the removable cover to the e-box.



FIGURE 1.2.0 YASKAWA KEYPAD BUTTONS

2.0 INSTALLATION

2.1 WIRING OPTIONS

2.1.1 "ON" Signal Connections

Depending on features installed, connect ON-SIGNAL connections either to the VFDs themselves, or to the low-voltage terminal strip in the ERV e-box. See schematics below.

Install a jumper between terminals 2 and 3 to use the ERV's on-board 24VAC power. Do this when the external control(s) have isolated contacts that don't provide any voltage, as in the top two examples. Make no connections between terminals 1 and 2 and terminals 3-5 if the external control has a voltage output to provide the "ON" signal. This voltage must be 24VAC.

⚠ WARNING

Capacitors in VFDs Retain Charge

Allow 3 minutes after shutting off power to the VFDs to allow the capacitors in the VFD to fully discharge. Do not connect or disconnect wires at the VFD without waiting 3 minutes.

2.2 WIRING SCHEMATICS

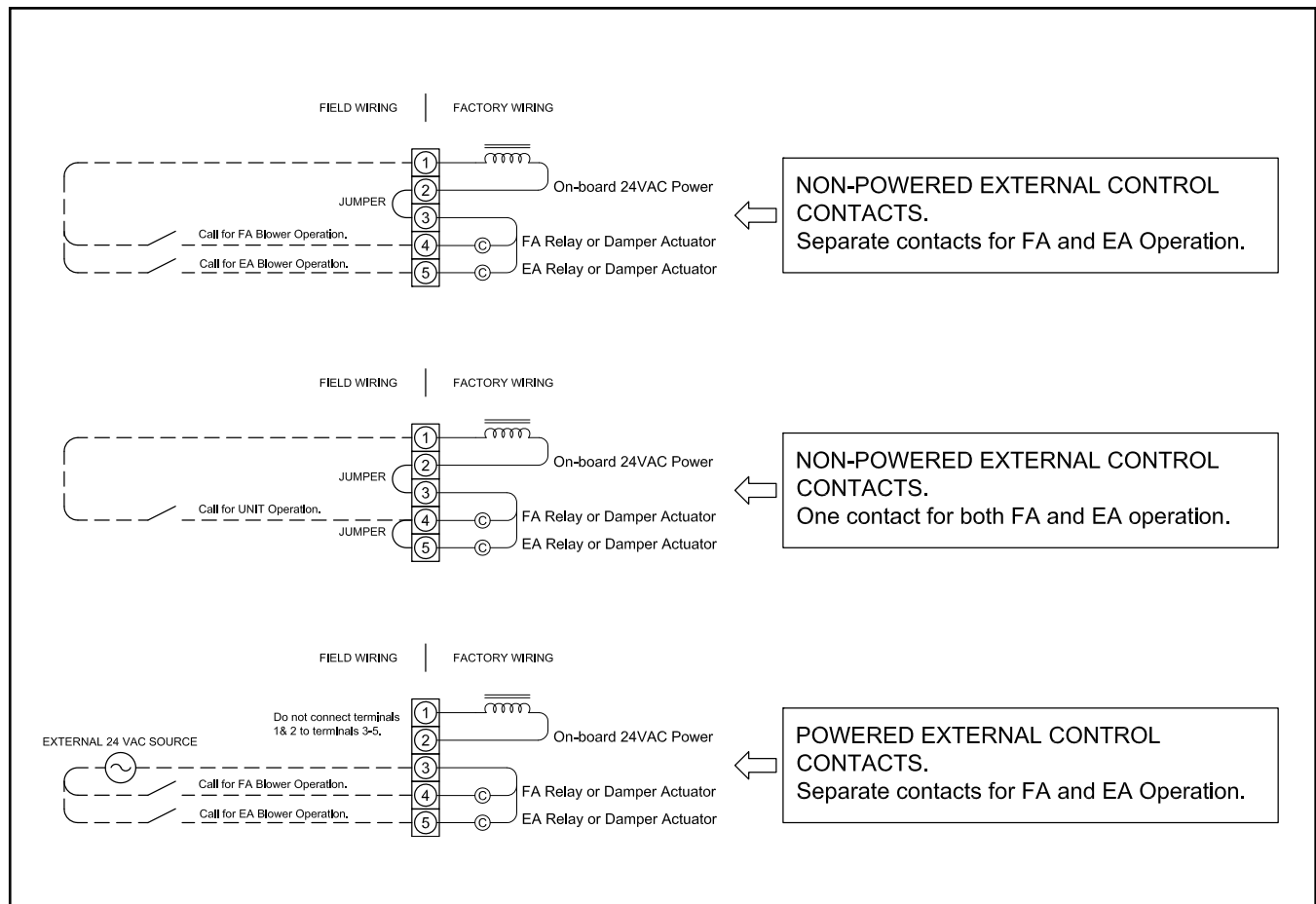

FIGURE 2.2.0 CONNECTION OF "ON" SIGNALS TO LOW-VOLTAGE TERMINAL STRIP IN ERV E-BOX

See Figure 2.2.0 for Relay or Damper Actuator Connection alternatives.

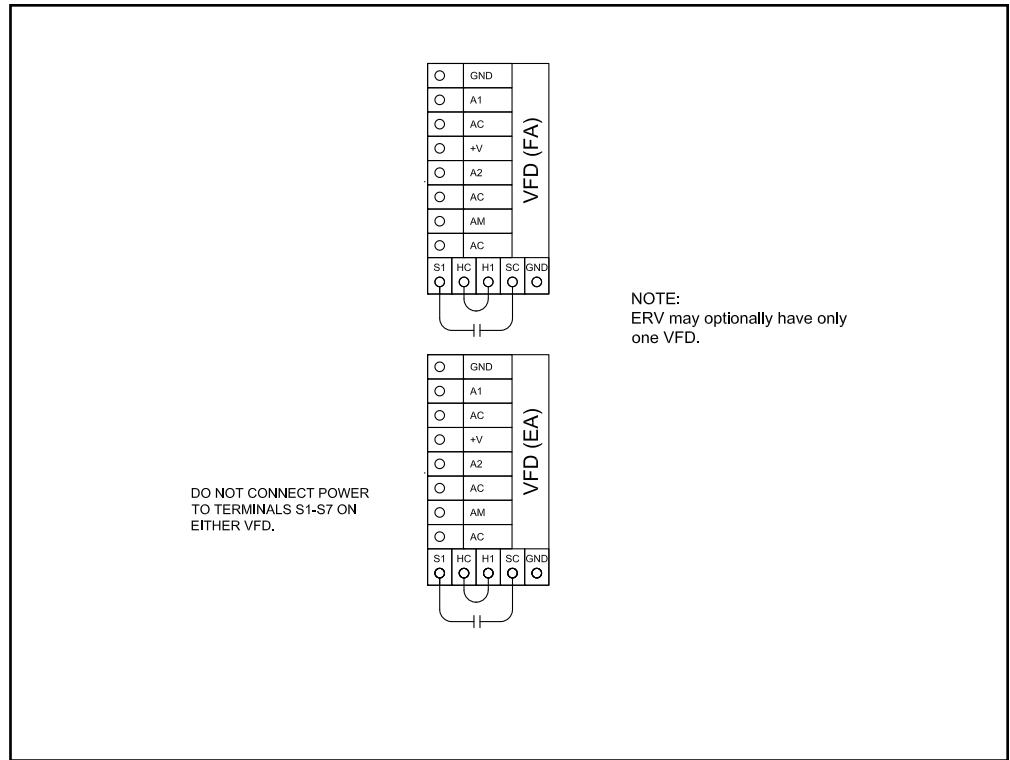

FIGURE 2.2.1 FACTORY CONTROL WIRING: “ON” SIGNALS CONNECTED TO EACH VFD

Alternative Control Wiring: “ON” signal connected directly to one VFD, passed to second VFD from terminals MA and MC.

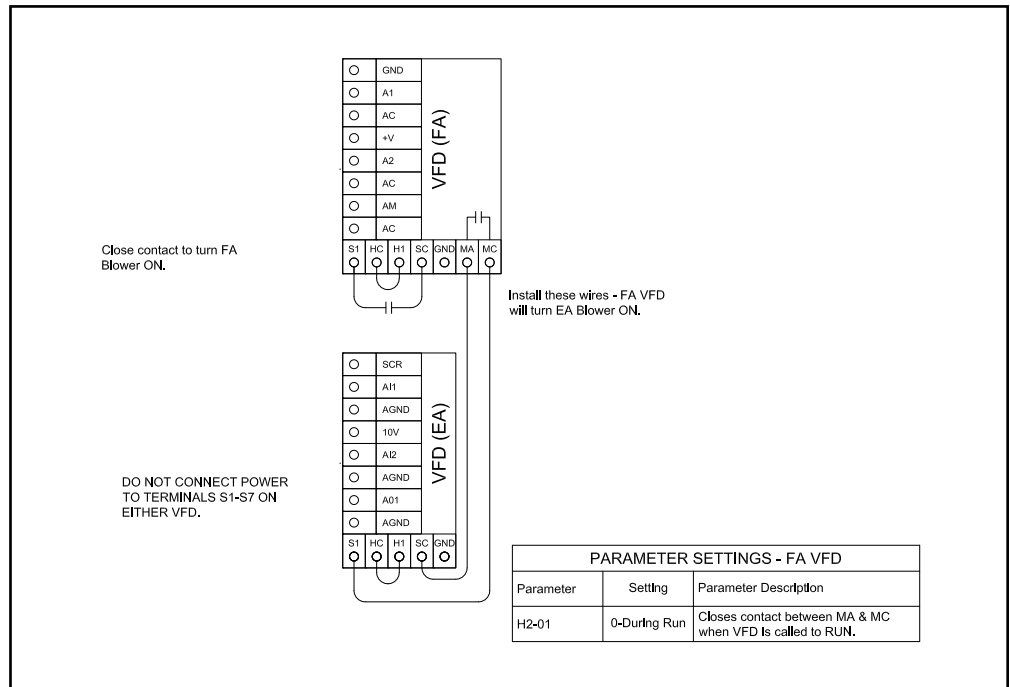

FIGURE 2.2.2 ALTERNATE CONTROL WIRING

2.2.1 Analog Inputs to Provide the “SPEED” Signal

Analog inputs are connected as shown below. It may be necessary to scale the response of the VFD to the analog “SPEED” signal.

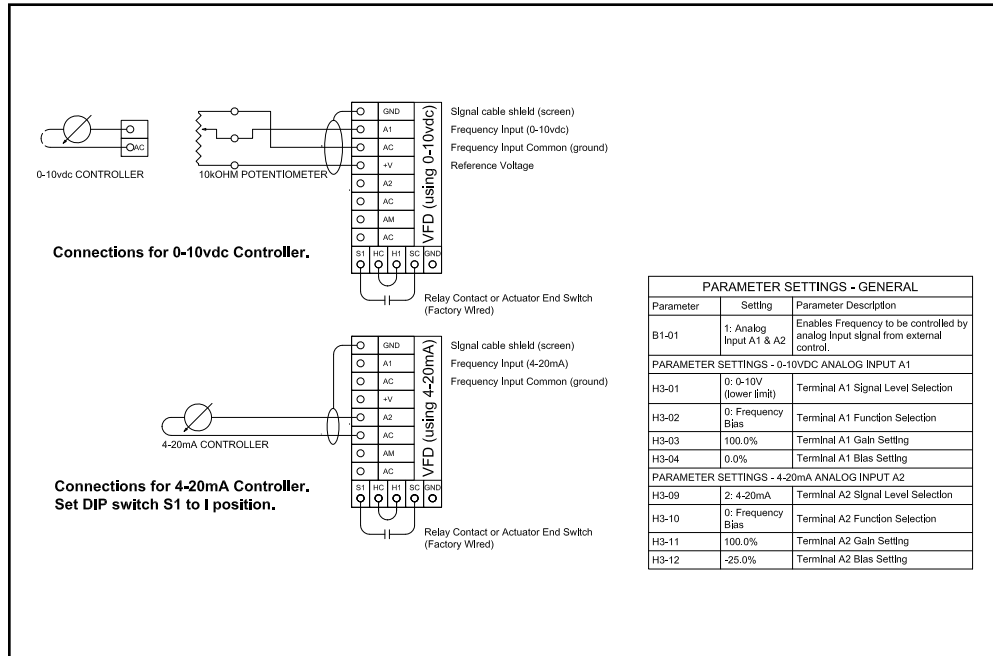

FIGURE 2.2.3 EXAMPLES OF ANALOG INPUT CONNECTIONS

2.2.2 Wiring Two VFDs for Leader-Follower Operation

One VFD can provide the “SPEED” signal to a second VFD, as shown below.

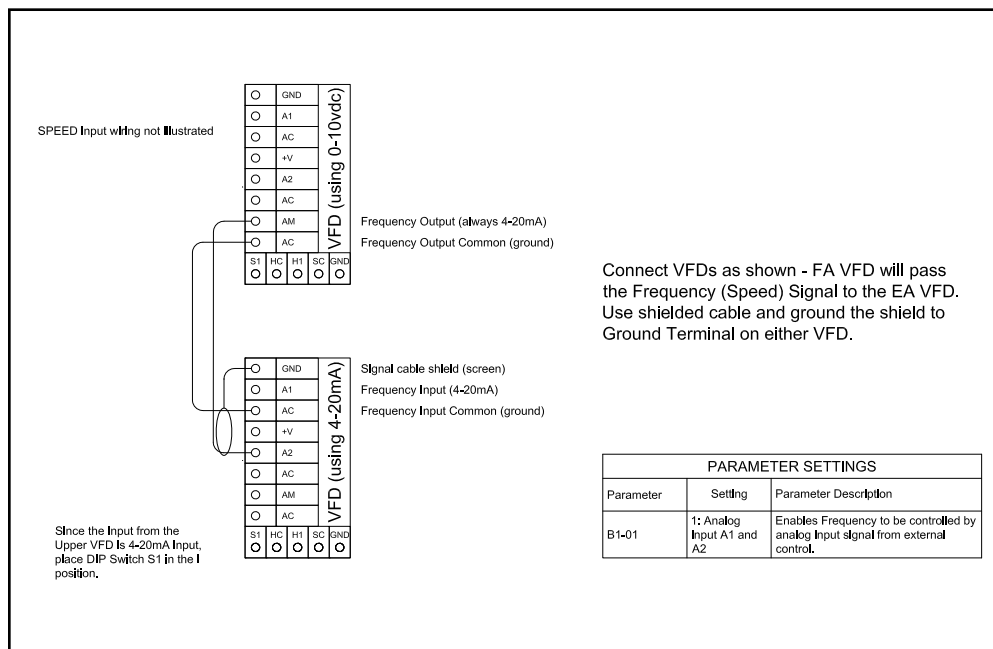

FIGURE 2.2.4 LEADER-FOLLOWER CONNECTION

NOTE: All wiring for analog signals connected to the VFDs should be double- or single-shielded twisted-pair cable. Ground the shield at one end of the cable only. The grounding clamp on the VFD may be used.

NOTE: If the FA VFD is controlled by an analog input signal, it is likely that the FA VFD's response to the analog input will be scaled, using parameters H3-03 and H3-04 for the A1 input, or H3-11 and H3-12 for the A2 input. See example VFD Parameter Scaling in section 3.3.8.

Parameter H4-02 and H4-03 can be used to scale the Analog Output of the Leader VFD in order to offset or correct the speed of the “Follower” VFD.

If both VFDs are to run at the same speed, no scaling parameters need be applied to the EA VFD since it is controlled as a “Follower.”

2.2.3 Using VFD Presets for the “SPEED” Signals

The VFD can be programmed with 3 pre-set speeds. Switches can then be used to direct the VFD to operate at one of those speeds. See Yaskawa manuals for additional options. Leader-follower wiring can also be used to make a second VFD operate at the same speed as the first VFD.

NOTE: Pre-set speeds override any Frequency (Speed) inputs.

Install Leader-Follower connection wiring if desired to operate second VFD at the same speeds.

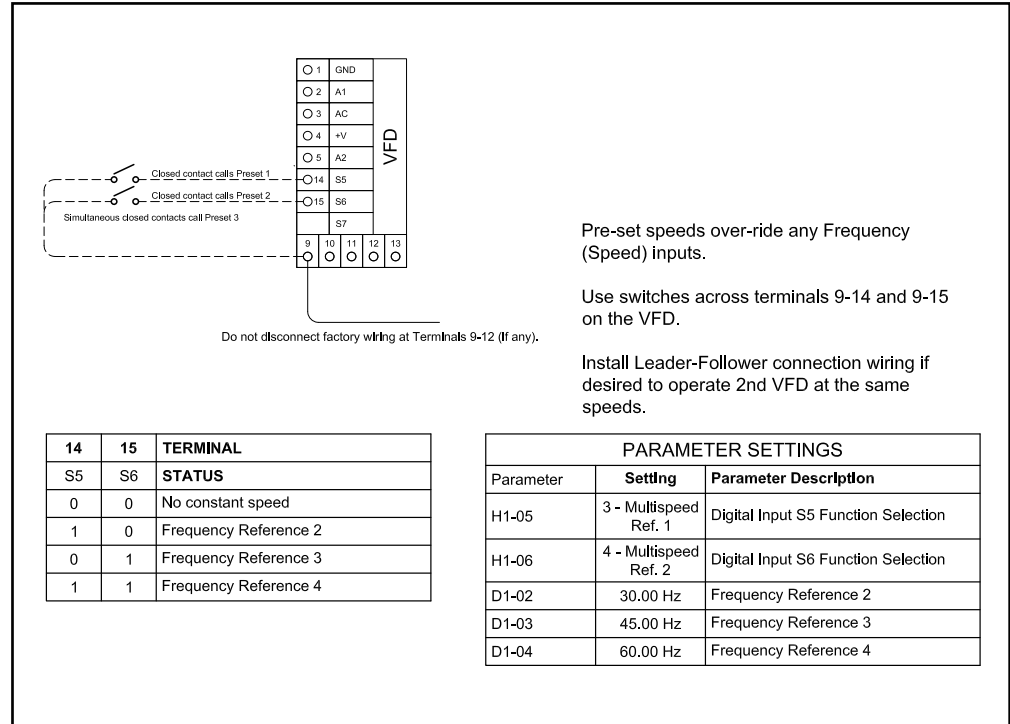

FIGURE 2.2.5 USE OF 3 SWITCHES TO COMMAND THE VFD TO OPERATE AT ANY OF 3 PRE-SET SPEEDS (SP4T SWITCH ALTERNATIVELY)

2.2.4 Use with a CO2 Controller

If both VFDs are to run at the same speed, no scaling parameters need be applied to the EA VFD in this example since it is controlled as a “Follower.” If it is required that the VFDs shut off when CO2 levels drop below a setpoint, connect the “normally open” contacts of the CO2 controller (terminals 3 and 4) to terminals S1 and SC of the FA VFD. Adjust the operating parameters of the CO2 controller to set the relay setpoint.

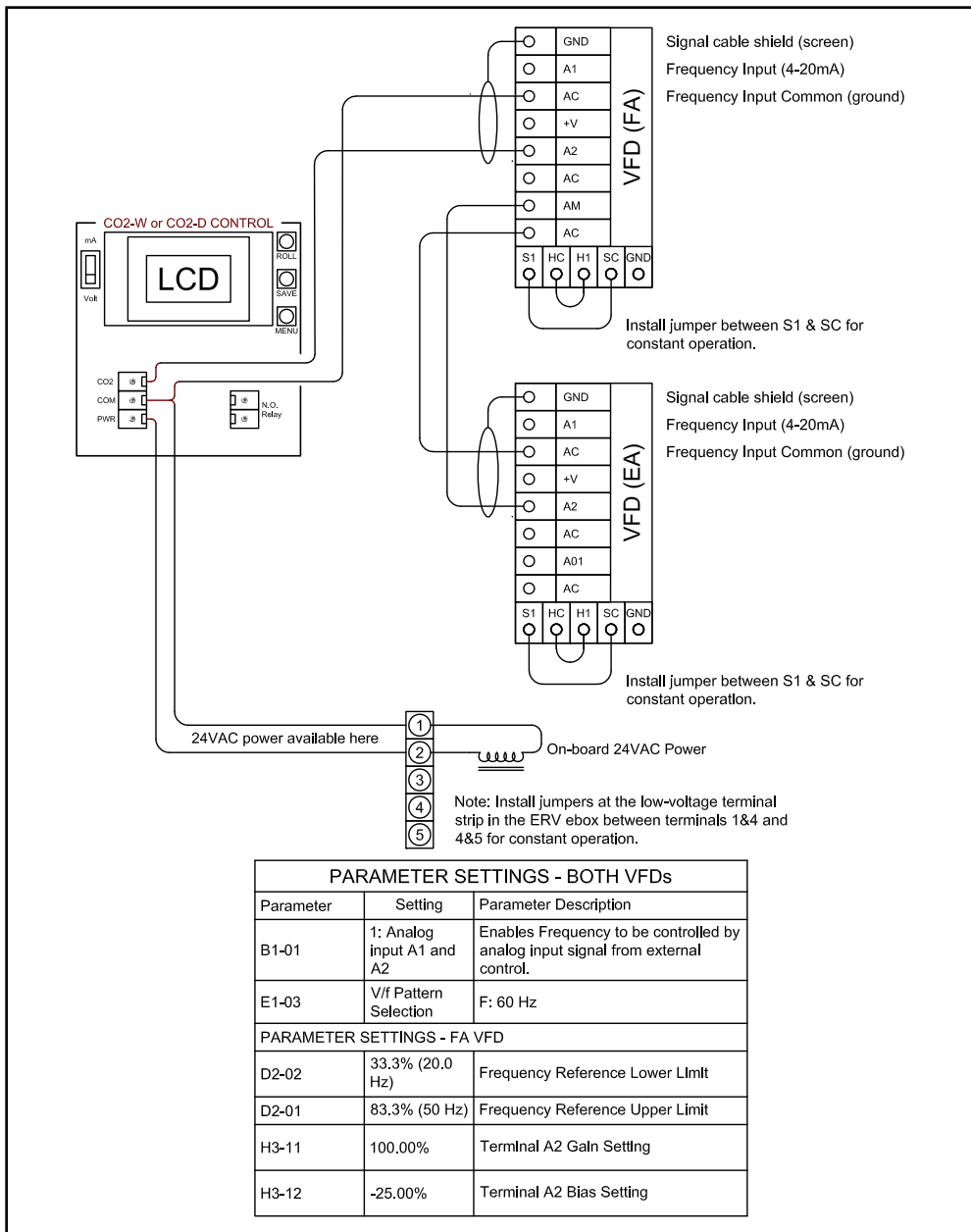

FIGURE 2.2.6 EXAMPLE OF OPERATION OF 2 VFDs BY A CO2 CONTROLLER

3.0 OPERATION

3.1 INITIAL START-UP

3.1.1 To Start ERV

1. Turn off power to the ERV at its Disconnect Switch.

Make sure the ERV is wired to provide an “ON” signal. (See Control Wiring Schematics later in this Manual.) You may need to install a temporary jumper at the ERV or VFD low-voltage terminal strip.

VFDs are set at the factory to respond to either the keypad or control terminal strip. If an external controller providing an analog input is connected to the VFD, the external controller will enable the VFD as long as the keypad is not put into a LOCAL control mode. Close ERV doors and main cover for the e-box; leave keypads accessible.

2. Turn on power to the ERV at its Disconnect Switch.

Wait for keypad display to appear.

3. For each VFD:

Press the “LO/RE” button on the keypad (green LED will illuminate), then press the “RUN ” button. Motor should start running at about 15 Hz.

With the VFD running, press the “ENTER” key when the display is showing the output frequency. Then use the keypad to input the desired frequency setpoint and press “ENTER” to save the setpoint. Confirm the motor amps are no greater than the motor FLA as listed on the unit nameplate by pressing the “UP” arrow button until the output current value is displayed (the last character will display the letter “A”).

4. To transfer control of the VFD to a control system:

Press the “STOP” button on the keypad. Motor should stop running.

Press the “LO/RE” button on the keypad. The green LED will turn off and the VFD will be controlled via control system.

3.1.2 Motor Protection by the VFD(s)

Each VFD in this unit protects one motor against overload. It is critical that the VFD Motor Overload be properly set using the full load amps (FLA) of the motor. The following Parameter must be set correctly and individually for each VFD to match the characteristics of the motor attached to it:

- E2-01 Motor Rated Current
- E2-04 Number of Motor Poles
- L3-02 Stall Level During Acceleration
- L3-06 Stall Level During Run

These parameters are set at RenewAire to match the motor controlled by the VFD. In most cases they should not be changed.

L3-02 and L3-06 are calculated using the following formula:

Stall Level = (Motor Rated Current / VFD FLA) X 1.25

3.2 SETTINGS

3.2.1 VFD Parameter Overview

“VFD Parameters” are instructions that the variable frequency drives follow. They can be adjusted by using the keypads on the VFDs. In some control configurations, they will need to be changed from the settings as shipped in the unit to interface with your control system.

3.2.2 To View All VFD Parameters

VFD must be powered up—something will be showing on the LED display.

1. Press the up-arrow key until PAr is displayed and press the “ENTER” key to access the parameter settings. Parameters are categorized into groups by letter and number (Example: C3-02). The first parameter shown is A1-01.
2. To change the parameter number, each character in the parameter number will have to be adjusted. When accessing a parameter, the letter will be flashing. While the letter is flashing, press the “UP” or “DOWN” arrow key to change its value. Once the letter has been selected, press the “RIGHT” arrow key once to make the first number flash. Press the “UP” or “DOWN” arrow key to change the number’s value. Repeat this process for all characters until the parameter number is displayed, then press the “ENTER” key.
3. The display will show the value of the selected parameter. If the motor is running, or if the VFD parameters are locked, the parameters can only be viewed and not changed.
4. Press the “ESC” button to go back to the parameter number adjustment screen and repeat steps 2–4 to view remaining desired parameters.

3.2.3 To Change VFD Parameters

VFDs are shipped locked to prevent accidental changes to parameter settings. If changes to factory parameter settings are desired, the VFD will need to be unlocked for editing the settings.

To unlock all Parameters:

1. Press the “UP” arrow key until PAr is displayed. Press the “ENTER” key.
2. Change the parameter to A1-04. Press the “ENTER” key.
3. Change the value from a “0000” to “0358.” Press the “ENTER” key.

All parameters should be visible/writable.

To lock all Parameters:

1. Press the “UP” arrow key until PAr is displayed. Press the “ENTER” key.
2. Change the parameter to A1-04. Press and hold the “STOP” key, then press the up-arrow key to display parameter A1-05. Press the “ENTER” key.
3. Change the value from a “0000” to “0358.” Press the “ENTER” key.
4. Change the parameter back to A1-04. Press the “ENTER” key.
5. The value should display “0000.” Press the “ENTER” key to lock the VFD parameters.

All parameters should be visible/readable but cannot be adjusted.

3.2.4 To Change VFD Parameters (when parameters are unlocked)

To modify VFD parameters, the VFD must not be enabled and applying power to the motor. If the motor is running, press the “STOP” softkey or remove the enable from the controls.

1. Press the up-arrow key until PAr is displayed and press the “ENTER” key to access the parameter settings. Parameters are categorized into groups by letter and number (example: C3-02). The first parameter shown is A1-01.
2. To change the parameter number, each character in the parameter number will have to be adjusted. When accessing a parameter, the letter will be flashing. While the letter is flashing, press the “UP” or “DOWN” arrow key to change its value. Once the letter has been selected, press the “RIGHT” arrow key once to make the first number flash. Press the “UP” or “DOWN” arrow key to change the number's value. Repeat this process for all characters until the parameter number is displayed, then press the “ENTER” key.
3. The display will show the default value of the selected parameter. Using the same process as step 2, change the values per the tables below. Once the desired value has been input, press the “ENTER” key. The word “END” will be displayed briefly to indicate the parameter has been changed. Then the parameter number that was just changed will be displayed again.
4. Repeat steps 2 and 3 to set remaining parameters.

3.2.5 To View Only Changed VFD Parameters

Select “urFy” in the “MENU” to verify none of the Parameters to be changed were missed and that the changed Parameters were correctly altered from the VFD default settings.

1. Press the “DOWN” arrow button until “urFy” is displayed and press “ENTER” key.
2. Parameter B3-01 should be displayed. Press “ENTER” key to verify the setting.
3. Press the “ENTER” key again to advance to the next parameter.
4. Repeat process until settings listed above have been verified.
5. If any parameters are not shown in the “urFy” list, set parameters per tables below.

3.2.6 Summary Table of Commonly Used Parameters with Standard AC Induction Motors

PARAMETER	NAME/SELECTION	YASKAWA V1000 DEFAULT SETTINGS	SETTINGS AS SHIPPED BY RENEWAIRE	COMMENTS
B1-01*	Frequency Reference Selection 1	1: Terminals (Analog Input Terminals)	1: Terminals (Analog Input Terminals)	Defines source of frequency command.
B1-02	Run Command Selection 1	1: Control Circuit Terminal	1: Control Circuit Terminal	Defines source of run command.
B1-03	Stopping Method Selection	0: Ramp to Stop	0: Ramp to Stop	VFD follows acceleration and deceleration times defined
B3-01	Speed Search Selection at Start	0: Disabled	1: Enabled	VFD will attempt to detect a free-wheeling motor before applying output power.
B3-24	Speed Search Method Selection	0: Current Detection Speed Search	1: Speed Estimation Speed Search	Speed estimation method will be used.
C1-01	Acceleration Time 1	10.0 s	10.0 s	Time to accelerate from 0 speed to maximum frequency.
C1-02	Deceleration Time 1	10.0 s	10.0 s	Time to decelerate from maximum frequency to 0 speed.
C6-02	Carrier Frequency Selection	7: Swing PWM 1	2: 5.0 kHz	Carrier frequency setting. If increased, may cause unintended derating of VFD output current capacity.
D1-02	Frequency Reference 2	0.00 Hz	30.00 Hz	Low fixed frequency setting.
D1-03	Frequency Reference 3	0.00 Hz	45.00 Hz	Medium fixed frequency setting.
D1-04	Frequency Reference 4	0.00 Hz	60.00 Hz	High fixed frequency setting.
D2-02	Frequency Reference Lower Limit	0%	HE and RPART–25.0% LE–16.7% DN–12.5%	Set per ERV type. Defines the minimum output frequency as a percentage of maximum frequency (E1-04 setting).
E1-04	Maximum Output Frequency	60 Hz	HE and RPART–60 Hz LE–90 Hz DN–120 Hz	Set per ERV type. Defines the maximum output frequency via the V/f pattern selected.
E1-05	Maximum Voltage	Varies	230V VFD: 230.0 V 460V VFD: 460.0 V	Set per input voltage rating of VFD.
E1-11	Middle Output Frequency 2	0.00 Hz	HE and RPART–60 Hz LE–75 Hz DN–90 Hz	Set per ERV type. Defines points for V/f pattern.
E1-12	Middle Output Frequency Voltage 2	0 V	230V VFD: 230.0 V 460V VFD: 460.0 V	Set per input voltage rating of VFD. Defines points for V/f pattern.
E2-01	Motor Rated Current	Varies	See Standard AC Motor Specific Settings Table	Set to the motor full load Amps output current rating on the nameplate.
E2-04	Number of Motor Poles	Varies	See Standard AC Motor Specific Settings Table	"1800 rpm motor = 4 pole 1200 rpm motor = 6 pole"
H1-01	S1 Digital Input Function Selection	40: Forward Run	40: Forward Run	Sets digital input S1 to forward run enable when connected to the SC terminal.
H1-05	S5 Digital Input Function Selection	3: Multi-Step Speed Reference 1	3: Multi-Step Speed Reference 1	Sets digital input S5 to Fixed Frequency Reference function 1 when connected to the SC terminal.

PARAMETER	NAME/SELECTION	YASKAWA V1000 DEFAULT SETTINGS	SETTINGS AS SHIPPED BY RENEWAIRE	COMMENTS
H1-06	S6 Digital Input Function Selection	4: Multi-Step Speed Reference 2	4: Multi-Step Speed Reference 2	Sets digital input S6 to Fixed Frequency Reference function 2 when connected to the SC terminal.
H2-01	Terminal MA, MB, and MC Function Setting (relay)	E: Fault	0: During Run	Sets function of relay output to close contacts between MA and MC terminals.
H3-01	Analog Input A1 Signal Level Selection	0: 0-10 Vdc with Limit	0: 0-10 Vdc with Limit	Sets the upper and lower limits of the analog input A1 range. Setting prevents frequency setpoint going negative when set to 0.
H3-02	Analog Input A1 Function Selection	0: Frequency Bias	0: Frequency Bias	The analog input A1 value will be added to the frequency reference.
H3-03	Terminal A1 Gain Setting	100.0%	100.0%	The analog input A1 value will be multiplied with the frequency reference
H3-04	Terminal A1 Bias Setting	0.0%	0.0%	Sets the analog input 1 Bias value to scale a 0-10 Vdc input signal.
H3-09	Analog Input A2 Signal Level Selection	2: 4-20 mA Current Input	2: 4-20 mA Current Input	Sets the upper and lower limits of the analog input A2 range. Setting prevents frequency setpoint going negative when set to 0.
H3-10	Analog Input A2 Function Selection	0: Frequency Bias	0: Frequency Bias	The analog input A2 value will be added to the frequency reference.
H3-11	Terminal A2 Gain Setting	100.0%	100%	The analog input A2 value will be multiplied with the frequency reference
H3-12	Terminal A2 Bias Setting	0.0%	-25.0%	Negative Symbol Required. Sets the analog input 2 Bias value to scale a 4-20 mA input signal.
L1-02	Motor Overload Protection Time	1.0 Minutes	0.2 Minutes	Sets the amount of time the VFD can output 120% VFD rated current before faulting.
L2-01	Momentary Power Loss Operation Selection	0: Disabled	2: CPU Power Active	Enables VFD to attempt to ride through momentary power loss.
L3-06	Stall Prevention During Run	Varies	See Standard AC Motor Specific Settings Table	"L3-06 = (Motor FLA / VFD FLA) X 1.25 CRITICAL PARAMETER. This provides motor protection!"
L5-01	Number of Auto Restart Attempts	0	10	Number of automatic fault reset attempts.

*If no digital or analog signals will be used for the frequency setpoint, set B1-01 to function 0 to set frequency setpoint via keypad.

 **NOTE: SPEED-SKIPPING** is a function available through Parameters D3-01 to D3-04. It allows up to 3 critical speeds to be skipped as the VFD ramps speed up and down. If noise problems occur at specific frequencies, Speed-Skipping may help. See the VFD manual for details.

3.2.7 208V Standard AC Motor Specific VFD Parameter Settings

# OF PH AND VOLTAGE	RA-YASKAWA VFD PN	YASKAWA MODEL #	VFD FLA	3PH MOTOR PN	MOTOR HP	MOTOR BRAND	PARAMETER #		
							E2-01	E2-04	L3-06
							MOTOR RATED CURRENT	# OF MOTOR POLES	STALL LEVEL DURING RUN
1 PH 208V	136831	CIMR-VUBA0006FAA	6	140625_000	3/4	Marathon	2.3	4	48%
1 PH 208V	136831	CIMR-VUBA0006FAA	6	135253_000	1	Soler & Palau	2.2	4	46%
1 PH 208V	136831	CIMR-VUBA0006FAA	6	136350_001 106350_000	1.5	Baldor	4.5	4	94%
1 PH 208V	136832	CIMR-VUBA0010FAA	9.6	136297_001	2	Marathon	6	4	78%
1 PH 208V	136832	CIMR-VUBA0010FAA	9.6	136351_001 106351_000	2	Baldor	6.6	4	86%
1 PH 208V	136832	CIMR-VUBA0010FAA	9.6	136352_002 106352_000	3	Baldor	9	4	117%
3 PH 208V	136834	CIMR-VU2A0004FAA	3.5	140625_000	3/4	Marathon	2.3	4	82%
3 PH 208V	136834	CIMR-VU2A0006FAA	6	135253_000	1	Soler & Palau	2.2	4	46%
3 PH 208V	136835	CIMR-VU2A0006FAA	6	136350_001 106350_000	1.5	Baldor	4.47	4	94%
3 PH 208V	136836	CIMR-VU2A0010FAA	9.6	136297_001	2	Marathon	6	4	78%
3 PH 208V	136836	CIMR-VU2A0010FAA	9.6	136351_001 106351_000	2	Baldor	6.6	4	86%
3 PH 208V	136836	CIMR-VU2A0010FAA	9.6	136352_002 106352_000	3	Baldor	8.48	4	117%
3 PH 208V	136838	CIMR-VU2A0020FAA	19.6	136295_000	5	Marathon	15	6	96%
3 PH 208V	136838	CIMR-VU2A0020FAA	19.6	135543_002	5	Grainger w/ Dayton**	14	4	89%
3 PH 208V	136838	CIMR-VU2A0020FAA	19.6	136353_002 106353_000	3	Baldor	13.9	4	89%
3 PH 208V	136839	CIMR-VU2A0030FAA	30	134314_002	7.5	Grainger w/ Dayton**	20.5	4	85%
3 PH 208V	136839	CIMR-VU2A0030FAA	30	136354_002 106354_000	7.5	Baldor	20	4	83%
3 PH 208V	136839	CIMR-VU2A0030FAA	30	134316_001	10	Grainger w/ Dayton**	26	4	108%
3 PH 208V	136839	CIMR-VU2A0030FAA	30	136355_002 106355_000	10	Baldor	25.4	4	106%
3 PH 208V	136839	CIMR-VU2A0030FAA	30	106353_000	5	Baldor*	27.8*	4	116%*

*DN-5 units have two 5 HP motors with a single 10 HP VFD per airstream. Parameter E2-01 is 2 x motor FLA. Parameter L3-06 is 1.25 x (2 x motor nameplate FLA) / VFD FLA.

**Motor PN shown is the Grainger Kit PN that can be seen in HE6X8X Job BOMs. Motor is supplied with the kit.

OPERATION

OPTION

Yaskawa Variable Frequency Drives

3.2.8 460V Standard AC Motor Specific VFD Parameter Settings

# OF PH AND VOLTAGE	RA-YASKAWA VFD PN	YASKAWA MODEL #	VFD FLA	3PH MOTOR PN	MOTOR HP	MOTOR BRAND	PARAMETER #		
							E2-01	E2-04	L3-06
							MOTOR RATED CURRENT	# OF MOTOR POLES	STALL LEVEL DURING RUN
3 PH 460V	136840	CIMR-VU4A0002FAA	2.1	140625_000	3/4	Marathon	1.15	4	68%
3 PH 460V	136840	CIMR-VU4A0002FAA	2.1	135253_000	1	Soler & Palau	1.13	4	67%
3 PH 460V	136841	CIMR-VU4A0004FAA	4.1	136298_001	2	Marathon	2.9	4	88%
3 PH 460V	136841	CIMR-VU4A0004FAA	4.1	136350_001 106350_000	1.5	Baldor	2.2	4	67%
3 PH 460V	136841	CIMR-VU4A0004FAA	4.1	136351_001 106351_000	2	Baldor	2.9	4	88%
3 PH 460V	136842	CIMR-VU4A0005FAA	5.4	136352_002 106352_000	3	Baldor	4.2	4	97%
3 PH 460V	136843	CIMR-VU4A0009FAA	8.8	136295_000	5	Marathon	7	6	99%
3 PH 460V	136843	CIMR-VU4A0009FAA	8.8	135543_002	5	Grainger w/ Dayton**	6.33	4	90%
3 PH 460V	136843	CIMR-VU4A0009FAA	8.8	136353_002 106353_000	5	Baldor	6.7	4	95%
3 PH 460V	136844	CIMR-VU4A0011FAA	11.1	134314_002	7.5	Grainger w/ Dayton**	9.25	4	104%
3 PH 460V	136844	CIMR-VU4A0011FAA	11.1	136354_002 106354_000	7.5	Baldor	9.5	4	107%
3 PH 460V	136845	CIMR-VU4A0018FAA	17.5	134316_001	10	Grainger w/ Dayton**	12.5	4	89%
3 PH 460V	136845	CIMR-VU4A0018FAA	17.5	136355_002 106355_000	10	Baldor	12	4	86%
3 PH 460V	136845	CIMR-VU4A0018FAA	17.5	106353_000	5	Baldor*	13.4*	4	96%*

*DN-5 units have two 5 HP motors with a single 10 HP VFD per airstream. Parameter E2-01 is 2 x motor FLA. Parameter L3-06 is 1.25 x (2 x motor nameplate FLA) / VFD FLA.

**Motor PN shown is the Grainger Kit PN that can be seen in HE6X8X Job BOMs. Motor is supplied with the kit.

3.2.9 RenewAire Yaskawa Parameter Settings—EC-Titanium Motors

PARAMETER	NAME/SELECTION	YASKAWA V1000 DEFAULT SETTINGS	SETTINGS AS SHIPPED BY RENEWAIRE	COMMENTS
A1-02	Control Mode Selection	0: V/f Control	5: PM Open Loop Vector	Enables VFD to control EC-Titanium motors.
B1-01*	Frequency Reference Selection 1	1: Terminals (Analog Input Terminals)	1: Terminals (Analog Input Terminals)	Defines source of frequency command.
B1-02	Run Command Selection 1	1: Control Circuit Terminal	1: Control Circuit Terminal	Defines source of run command.
B1-03	Stopping Method Selection	0: Ramp to Stop	0: Ramp to Stop	VFD follows acceleration and deceleration times defined
B3-01	Speed Search Selection at Start	0: Disabled	1: Enabled	VFD will attempt to detect a free-wheeling motor before applying output power.
C1-01	Acceleration Time 1	10.0 s	20.0 s	Time to accelerate from 0 speed to maximum frequency.
C1-02	Deceleration Time 1	10.0 s	20.0 s	Time to decelerate from maximum frequency to 0 speed.
C2-01	S-Curve Characteristic at Accel Start	Varies	10.00 s	Smooths frequency output during transition from acceleration/deceleration to setpoint frequency operation.
C2-02	S-Curve Characteristic at Accel End	0.20 s	10.00 s	
C2-03	S-Curve Characteristic at Decel Start	0.20 s	10.00 s	
C2-04	S-Curve Characteristic at Decel End	0.00 s	10.00 s	
C6-02	Carrier Frequency Selection	7: Swing PWM 1	2: 5.0 kHz	Carrier frequency setting. If increased, may cause unintended derating of VFD output current capacity.
D1-02	Frequency Reference 2	0.00 Hz	30.00 Hz	Low fixed frequency setting.
D1-03	Frequency Reference 3	0.00 Hz	45.00 Hz	Medium fixed frequency setting.
D1-04	Frequency Reference 4	0.00 Hz	60.00 Hz	High fixed frequency setting.
D2-02	Frequency Reference Lower Limit	0%	HE and RPART–25.0%	Set per ERV type. Defines the minimum output frequency as a percentage of maximum frequency (E1-04 setting).
			LE–16.7%	
			DN–12.5%	
E1-04	Maximum Output Frequency	60 Hz	HE and RPART–60 Hz	Set per ERV type. Defines the maximum output frequency via the V/f pattern selected.
			LE–90 Hz	
			DN–120 Hz	
E1-05	Maximum Voltage	Varies	230V VFD: 230.0 V	Set per input voltage rating of VFD.
			460V VFD: 460.0 V	
E1-06	Base Frequency	60 Hz	60 Hz	Sets the base frequency rating of the motor.
E1-09	Minimum Frequency	Varies	6 Hz	Sets the minimum operating frequency of the EC Titanium motor.
E5-01	PM Motor Code Selection	Varies	FFFF	Sets motor type to non-Yaskawa PM motor.
E5-02	Motor Rated Power (PM)	Varies	See EC-Titanium Motor Specific Settings Table	Set per motor nameplate data. Units in kW.

PARAMETER	NAME/SELECTION	YASKAWA V1000 DEFAULT SETTINGS	SETTINGS AS SHIPPED BY RENEWAIRE	COMMENTS
E5-03	Motor Rated Current (PM)	Varies	See EC-Titanium Motor Specific Settings Table	Set per motor nameplate data. Units in kW.
E5-04	Number of Motor Poles (PM)	Varies	4	EC-Titanium motors are 4-pole motors.
E5-05	Motor Stator Resistance (PM)	Varies	See EC-Titanium Motor Specific Settings Table	Stator resistance equals motor nameplate data divided by 2. Units in Ohms.
E5-06	Motor d Axis Inductance (PM)	Varies	See EC-Titanium Motor Specific Settings Table	Set per motor nameplate data. Units in mH.
E5-07	Motor q Axis Inductance (PM)	Varies	See EC-Titanium Motor Specific Settings Table	Set per motor nameplate data. Units in mH.
E5-09	Motor Induction Voltage Constant 1	Varies	0	Units in V/kRPM.
E5-24	Motor Induction Voltage Constant 2	Varies	See EC-Titanium Motor Specific Settings Table	Units in V/kRPM.
H1-01	S1 Digital Input Function Selection	40: Forward Run	40: Forward Run	Sets digital input S1 to forward run enable when connected to the SC terminal.
H2-01	Terminal MA, MB, and MC Function Setting (relay)	E: Fault	0: During Run	Sets function of relay output to close contacts between MA and MC terminals.
H3-01	Analog Input A1 Signal Level Selection	0: 0-10 Vdc with Limit	0: 0-10 Vdc with Limit	Sets the upper and lower limits of the analog input A1 range. Setting prevents frequency setpoint going negative when set to 0.
H3-02	Analog Input A1 Function Selection	0: Frequency Bias	0: Frequency Bias	The analog input A1 value will be added to the frequency reference.
H3-03	Terminal A1 Gain Setting	100.0%	100.0%	The analog input A1 value will be multiplied with the frequency reference
H3-04	Terminal A1 Bias Setting	0.0%	0.0%	Sets the analog input 1 Bias value to scale a 0-10 Vdc input signal.
L1-02	Motor Overload Protection Time	1.0 Minutes	0.2 Minutes	Sets the amount of time the VFD can output 120% VFD rated current before faulting.
L2-01	Momentary Power Loss Operation Selection	0: Disabled	2: CPU Power Active	Enables VFD to attempt to ride through momentary power loss.
L3-06	Stall Prevention During Run	Varies	See EC-Titanium Motor Specific Settings Table	"L3-06 = (Motor FLA / VFD FLA) X 1.25 CRITICAL PARAMETER. This provides motor protection!"
L5-01	Number of Auto Restart Attempts	0	10	Number of automatic fault reset attempts.
N8-51	Acceleration/Deceleration Time Pull-In Current	Varies	30%	Sets the d-axis current during accel. and decel. as a percentage of the motor rated current.
N8-55	Load Inertia	0	3	Sets the ratio between motor inertia and the inertia of the connected machinery.
N8-62	Output Voltage Limit	Varies	"230V VFD: 230.0 V 460V VFD: 460.0 V"	Limits the maximum voltage applied to the motor.

3.2.10 230V EC-Titanium Motor Specific VFD Parameter Settings*

# OF PH AND VOLTAGE	RA-YASKAWA VFD PN	3PH MOTOR PN	MOTOR HP	MOTOR BRAND	PARAMETER #						
					E5-02	E5-03	E5-05	E5-06	E5-07	E5-24	L3-06
					MOTOR RATED POWER	MOTOR RATED CURRENT	MOTOR STATOR RES.	MOTOR D AXIS IND.	MOTOR Q AXIS IND.	MOTOR VOLTAGE CONST. 2	STALL LEVEL DURING RUN
1 PH 208V	136832	106371	2	Baldor EC Titanium	1.5	4.5	1.12	27.1	87.9	124	59%
1 PH 208V	136832	106372	3	Baldor EC Titanium	2.2	7.3	1.11	14.4	54.4	58.9	96%
3 PH 208V	136836	106371	2	Baldor EC Titanium	1.5	4.5	1.12	27.1	87.9	124	59%
3 PH 208V	136836	106372	3	Baldor EC Titanium	2.2	7.3	1.11	14.4	54.4	58.9	96%
3 PH 208V	136838	106373	5	Baldor EC Titanium	3.7	10.5	0.41	13.5	47.8	70	67%
3 PH 208V	136839	106374	7.5	Baldor EC Titanium	5.5	17.4	0.18	6.6	20.4	62.8	73%
3 PH 208V	136839	106375	10	Baldor EC Titanium	7.5	22	0.12	5.5	19.2	75.2	92%

*EC-Titanium parameter settings must only be utilized when ERV is equipped with Baldor EC-Titanium motors. Settings not compatible with standard AC induction motors.

3.2.11 460V EC-Titanium Motor Specific VFD Parameter Settings*

# OF PH AND VOLTAGE	RA-YASKAWA VFD PN	3PH MOTOR PN	MOTOR HP	MOTOR BRAND	PARAMETER #						
					E5-02	E5-03	E5-05	E5-06	E5-07	E5-24	L3-06
					MOTOR RATED POWER	MOTOR RATED CURRENT	MOTOR STATOR RES.	MOTOR D AXIS IND.	MOTOR Q AXIS IND.	MOTOR VOLTAGE CONST. 2	STALL LEVEL DURING RUN
3 PH 460V	136841	106371	2	Baldor EC Titanium	1.5	2.3	5.25	108	351.6	138	70%
3 PH 460V	136842	106372	3	Baldor EC Titanium	2.2	3.7	4.4	57.7	217.7	118	86%
3 PH 460V	136843	106373	5	Baldor EC Titanium	3.7	5.3	1.65	54	191	140	75%
3 PH 460V	136844	106374	7.5	Baldor EC Titanium	5.5	8.7	0.7	26.5	81.4	125	98%
3 PH 460V	136845	106375	10	Baldor EC Titanium	7.5	11	0.47	29.1	76.7	149	79%

*EC-Titanium parameter settings must only be utilized when ERV is equipped with Baldor EC-Titanium motors. Settings not compatible with standard AC induction motors.

3.2.12 To Reset VFD Parameters to Factory Settings using Keypad

The VFD will need to be unlocked as described on in section 3.3 to reset Parameters to RenewAire factory or Yaskawa defaults.

To return to RenewAire's defaults, complete the following steps:

1. Press the "UP" arrow key until PAr is displayed. Press the "ENTER" key.
2. Change the parameter to A1-03. Press the "ENTER" key.
3. Change the value from a "0000" to "1110." Press the "ENTER" key.
4. The backup parameters should now overwrite any existing parameter settings.
5. The parameters should be verified using the "urFy" process outlined in section 3.3.

To return to Yaskawa's defaults, complete the following steps:

1. Press the "UP" arrow key until PAr is displayed. Press the "ENTER" key.
2. Change the parameter to A1-03. Press the "ENTER" key.
3. Change the value from a "0000" to "2220." Press the "ENTER" key.
4. The Yaskawa factory default parameters should now overwrite any existing parameter settings.
5. The parameters should be verified using the "urFy" process outlined in section 3.3.

To save an edited parameter set for possible restoration, complete the following steps:

1. Press the "UP" arrow key until PAr is displayed. Press the "ENTER" key.
2. Change the parameter to O2-03. Press the "ENTER" key.
3. Change the value from a "0" to "1." Press the "ENTER" key.
4. The parameters are now backed up to the VFDs internal memory.

There is no option to save the parameters in the remote-mounted keypad for Yaskawa V1000 VFDs.

The VFD should be relocked as described in section 3.3 after the desired parameter settings are entered to avoid further, accidental changes to parameter settings.



NOTE: VFD Manufacturer instructions list many other parameters. Copies of the complete manufacturer's instructions for the VFD are shipped with this unit, and are also available online in the Downloads page at <https://www.yaskawa.com/downloads>.

⚠ WARNING

DANGER OF MOTOR OVERLOAD LEADING TO SMOKE AND FIRE!

Do not change parameters L3-02 and L3-06 from RenewAire default settings, which should be set to no more than 125% of the ratio of Motor FLA / VFD FLA. These parameters set the limits of output current provided by the VFD.

3.2.13 Scaling and Response to Analog Inputs

The most likely reason to control the VFD from an analog signal is automatically change the amount of outside air ventilation to meet the actual needs for each time period.

If one or both of the VFDs will be controlled by an analog input from an external Control Device (e.g. a CO2 controller or a Building Management System), you may need to “scale” the rate of response of the VFD(s) to the rate of change of the analog signal. Usually only one of the two VFDs requires scaling.

We need to introduce two concepts relating to the amount of outside air ventilation needed in the building:

- ♦ The “ACTION LEVEL” (AL) is the level of measurement of indoor air quality or occupancy at which the ERV Unit should start to deliver more than the “Design Minimum Supply Airflow;”
- ♦ The “MAXIMUM RESPONSE LEVEL” (MRL) is the level of measurement of indoor air quality or occupancy at which the ERV Unit should be operating at the “Design Maximum Supply Airflow.”

3.2.14 Additional Job Information Needed

1. **Input Type (IT)** of analog signal: VDC or mA
2. **Minimum Signal Value (MinSV)** of the analog signal: e.g. 0VDC or 4mA.
3. **Maximum Signal Value (MaxSV)** of the analog signal: e.g. 10VDC, 20mA
4. **Measurement Range (MR):** the range of the values that can be measured by the Control Device (e.g. a controller set to measure CO2 from 0ppm to 2000ppm).
5. **Action Level Signal (ALS):** the value of the analog signal corresponding to the “Action Level.”
6. **Maximum Response Level Signal (MRLS):** the value of the analog signal corresponding to the “Maximum Response Level.”
7. **Maximum Hertz (MaxH):** VFD frequency setting at maximum design airflow. This was determined during the initial balancing process.
8. **Minimum Hertz (MinH):** setting corresponding to minimum design airflow, again determined during the initial balancing process.
9. Whether ventilation should stop whenever air quality is below the “Action Level,” or should continue at minimum design airflow.

3.2.15 Application Example: CO2 Controller

Consider the following building provided with outside air ventilation by an ERV Unit:

- ♦ The engineer requires a minimum outside air ventilation rate of 700 CFM at all times in order to control the level of indoor air pollutants generated by the furnishings.
- ♦ To address the higher level of ventilation required when the building is occupied, the engineer specifies that a CO2 controller shall be used to increase ventilation if CO2 levels rise above 600ppm.
- ♦ The engineer specifies a maximum outside air ventilation rate of 1500 CFM and expects this to restrain CO2 levels to 1000ppm.

In short, the ventilation requirements call for the ERV Unit to be running at no less than 700CFM at all times. When CO2 levels increase above 600ppm, the airflow volume should increase, reaching a maximum of 1500CFM at a CO2 level of 1000ppm.

Turning to the equipment itself:

- The CO2 controller is set up to deliver a linear 4–20mA signal over a measurement range of 0–2000ppm.
Therefore: the “INPUT TYPE” (IT) = mA.
The Minimum Signal Value (MinSV) = 4mA.
The Maximum Signal Value (MaxSV) = 20mA.
The Measurement Range (MR) = 0–2000ppm.
- During Balancing we recorded VFD frequencies of 50hz at 1500 CFM, and 20hz at 700CFM.
Therefore: “Maximum Hertz (MaxH) = 50.
“Minimum Hertz” (MinH) = 20.
- From the engineer’s requirements:
the “Action Level” = 600ppm;
the “Maximum Response Level” = 1000ppm.

1. Determine the minimum and maximum operation frequency setpoints as a percentage of the maximum V/f Pattern Selection frequency (E1-03). Assuming the maximum V/f Pattern Selection frequency is 60 Hz (E1-03 = F), minimum operation frequency (MinH) is 20 Hz, and maximum operation frequency (MaxH) is 50 Hz:

- a. Set parameter D2-01 (Frequency Reference Upper Limit)

$$\text{Freq. Ref. Upper Limit} = \left[\frac{50 \text{ (Hz)}}{60 \text{ (Hz)}} \times 100\% \right]$$

$$\text{Freq. Ref. Upper Limit} = 83.3\%$$

- b. Set parameter D2-02 (Frequency Reference Lower Limit)

$$\text{Freq. Ref. Lower Limit} = \left[\frac{20 \text{ (Hz)}}{60 \text{ (Hz)}} \times 100\% \right]$$

$$\text{Freq. Ref. Lower Limit} = 33.3\%$$

2. Calculate the ALS, the value of the analog signal from the controller when CO2 = 600 ppm:

$$\text{ALS} = \text{MinSV} + \left[\frac{\text{ACTION_LEVEL}}{\text{MR}} \times (\text{MaxSV} - \text{MinSV}) \right]$$

Therefore:

$$\text{ALS} = 4 \text{ (mA)} + \left[\frac{600 \text{ (ppm)}}{2000 \text{ (ppm)}} \times 16 \text{ (mA)} \right] = 8.8 \text{ (mA)}$$

3. The calculated ALS now needs to be expressed as a percentage of the MR, but since the MinSV = 4.0, calculate as follows:

$$\left[\frac{8.8 \text{ (mA)} - 4.0 \text{ (mA)}}{16.0 \text{ (mA)}} \right] \times 100 \text{ (\%)} = 30\%$$

4. Calculate the MRLS, the value of the analog signal from the controller when CO2 = 1000 ppm:

$$\text{MRLS} = \text{MinSV} + \left[\frac{\text{MRLS}}{\text{MR}} \times (\text{MaxSV} - \text{MinSV}) \right]$$

$$\text{MRLS} = 4.0 \text{ (mA)} + \left[\frac{1000 \text{ (ppm)}}{2000 \text{ (ppm)}} \times 16 \text{ (mA)} \right] = 12 \text{ (mA)}$$

5. This calculated MRLS now needs to be expressed as a percentage of the MR, but since the MinSL = 4.0, calculate as follows:

$$\left[\frac{12 \text{ (mA)} - 4.0 \text{ (mA)}}{16.0 \text{ (mA)}} \times 100 \text{ (\%)} \right] = 50\%$$

6. With this information, the Slope (m) of the signal level needs to be calculated. This is done with the Frequency Reference Upper Limit, Frequency Reference Lower Limit, ALS, and MRLS. Calculate as follows:

$$m = \left[\frac{\text{Freq. Ref Upper Limit} - \text{Freq. Ref Lower Limit}}{\text{(MRLS} - \text{ALS)}} \right]$$

$$m = \left[\frac{83.3 \text{ (\%)} - 33.3 \text{ (\%)}}{(50 \text{ (\%)} - 30 \text{ (\%)})} \right] = 2.5$$

7. Finally, the analog input BIAS (%) setting needs to be calculated which is the y-intercept value (b). This can be done with the Frequency Reference Lower Limit, ALS, and Slope. Calculate as follows:

$$\text{Freq. Ref Lower Limit} = \left[\text{Slope (m)} \times \text{ALS} \right] + \text{Bias (b)}$$

$$\text{Bias (b)} = \text{Freq. Ref Lower Limit} - \left[\text{Slope (m)} \times \text{ALS} \right]$$

$$\text{Bias (b)} = 33.3 \text{ (\%)} - \left[2.5 \times 30 \text{ (\%)} \right] = -41.7 \text{ (\%)}$$

- a. For Analog Input 2 (A2), set the Terminal A2 Bias Setting in parameter H3-12 to -41.7 %.
- b. Since, in this example, the CO2 controller is set up to deliver a linear 4–20 mA signal over a measurement range of 0 to 2000 ppm, set the Terminal A2 Gain Setting in parameter H3-11 to 100.0% to match the 20 mA max value of the controller.

In this application example, the ERV unit is intended to run continuously. If the measured CO2 concentration is below the Action Level, the unit will run at the Minimum Design Airflow established by D2-02. However, if it were desired to shut down the ERV unit at all CO2 levels below the Action Level, use the normally open contacts on the CO2 controller to disable the unit. See section 2.2.4 for more information.

PARAMETERS USED IN SCALING		
Parameters		Values
B1-01	Frequency Reference Selection	1 = Terminals (Analog Input Terminals)
D2-01	Frequency Reference Upper Limit	Input the value as a percentage of VFD maximum frequency
D2-02	Frequency Reference Lower Limit	Input the value as a percentage of VFD maximum frequency
E1-03	V/f Pattern Selection	Set per the ERV type. HE = F: 60 Hz, LE = C: 90 Hz
H3-11	Terminal A2 Bias Setting	Set per the procedure summarized above
H3-12	Terminal A2 Gain Setting	Set per the procedure summarized above

3.2.16 Example of VFD Scaling

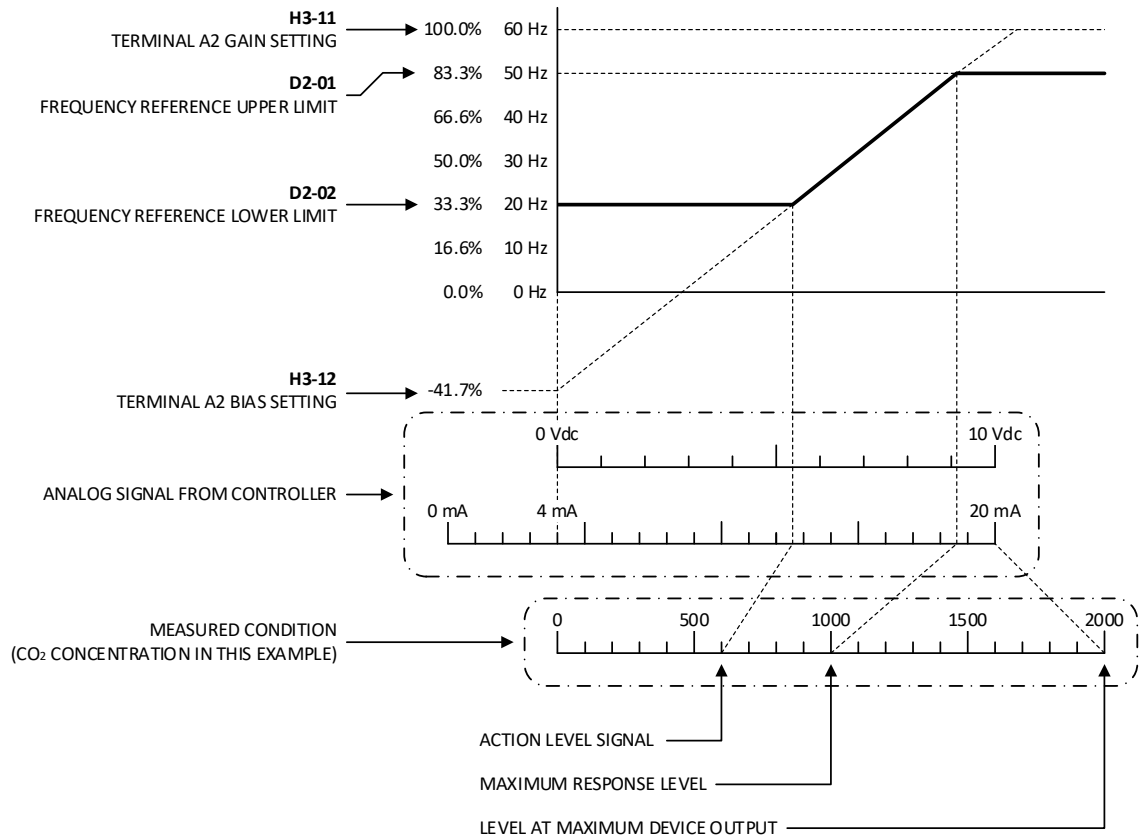

4.0 FACTORY ASSISTANCE

For questions about applications not covered in this manual, and for questions specific to the Yaskawa Drives, contact Yaskawa Technical Support at 1-800-YASKAWA (927-5292), dial 24.

A listing of Yaskawa support and service contacts can be found on the Internet at <https://www.yaskawa.com/support-training/support>.

Yaskawa manuals are available as PDFs at <https://www.yaskawa.com/downloads>; select Inverter Drives, then select V1000.

Related Yaskawa Manuals:

Yaskawa AC Drive-V1000 Technical Manual SEIP C710606 18F

Yaskawa AC Drive-V1000 Quick Start Guide TOEP C710606 47D

LCD Operator Installation Manual TOBP C730600 29G

BACnet MS/TP Installation and Technical Manual TOEP YAICOM 19B

Yaskawa offers training courses on their VFDs; navigate to <https://www.yaskawa.com/support-training/training> to view available offerings.

For questions about applications covered in this manual, and for questions about how the VFDs are installed in your RenewAire ERV unit, contact RenewAire Customer Support at (800)-627-4499.



About RenewAire

For over 40 years, **RenewAire has been a pioneer in enhancing indoor air quality (IAQ)** in commercial and residential buildings of every size. This is achieved while maximizing sustainability through our fifth-generation, static-plate, enthalpic-core **Energy Recovery Ventilators (ERVs) that optimize energy efficiency**, lower capital costs via load reduction and decrease operational expenses by minimizing equipment needs, resulting in significant energy savings. Our ERVs are competitively priced, simple to install, easy to use and maintain and have a quick payback. They also enjoy the industry's best warranty with the lowest claims due to long-term reliability derived from innovative design practices, expert workmanship and **Quick Response Manufacturing (QRM)**.

As the pioneer of static-plate core technology in North America, RenewAire is the largest ERV producer in the USA. We're **committed to sustainable manufacturing** and lessening our environmental footprint, and to that end our Waunakee, WI plant is 100% powered by wind turbines. The facility is also one of the few buildings worldwide to be LEED® Gold and Green Globes certified, as well as having achieved ENERGY STAR Building status. In 2010, RenewAire joined the Soler & Palau (S&P) Ventilation Group in order to provide direct access to the latest in energy-efficient air-moving technologies. For more information, visit: renewaire.com

201 Raemisch Road | Waunakee, WI | 53597 | 800.627.4499 | [RenewAire.com](https://renewaire.com)